



# Castle

7097

1

**WARNING: CHOKING HAZARD.**  
Toy contains small parts and a small ball.  
Not for children under 3 years.





# 1

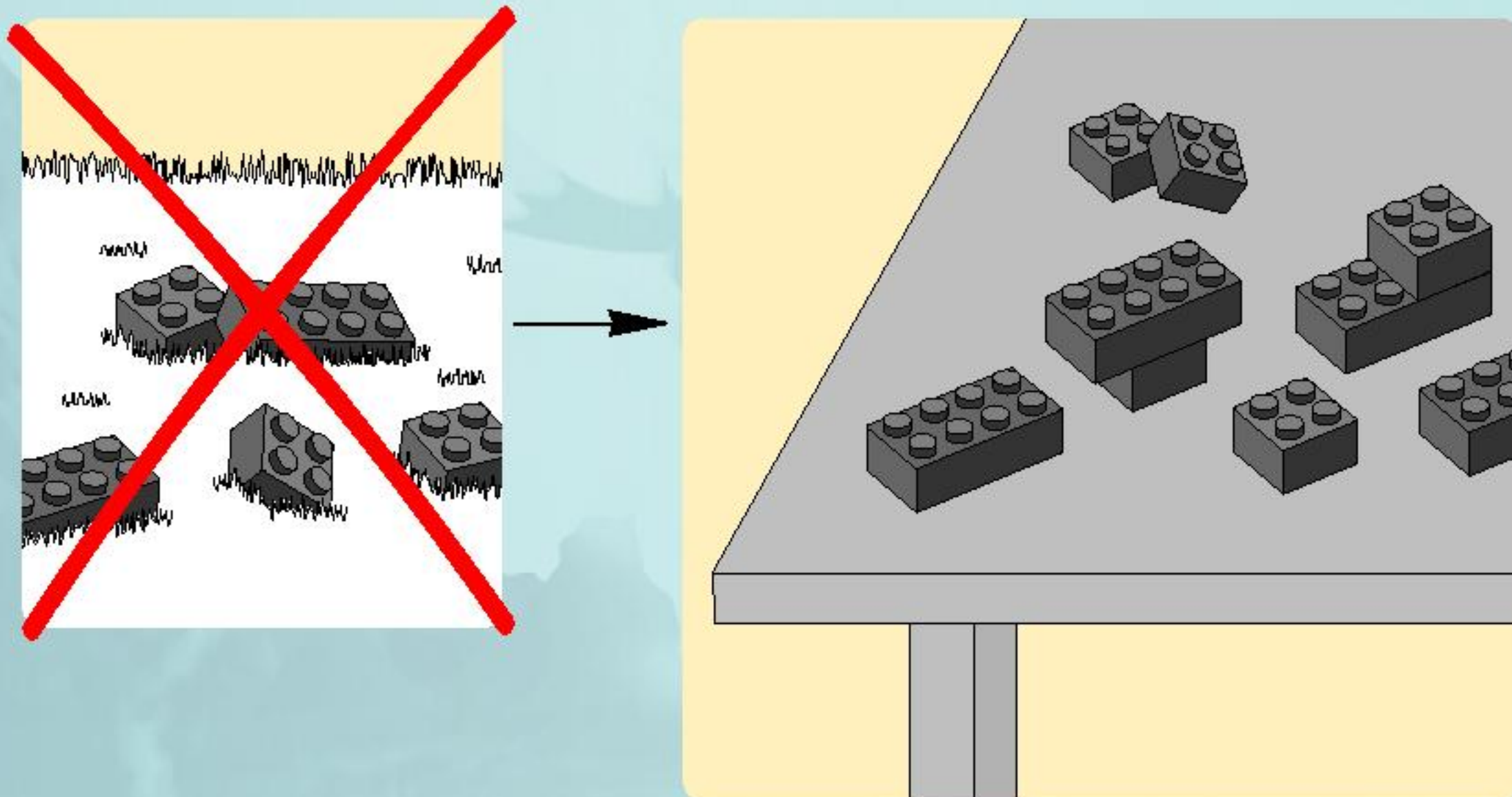

# 2



**⚠ AVERTISSEMENT : RISQUE D'ÉTOUFFEMENT.**

Le jouet contient des petites pièces ainsi qu'une petite boule. Il ne convient pas aux enfants de moins de 3 ans.

**⚠ ADVERTENCIA: PELIGRO DE ASFIXIA.**

Juguete que contiene partes pequeñas y una pelota pequeña. No recomendado para niños menores de 3 años.





1

+



2

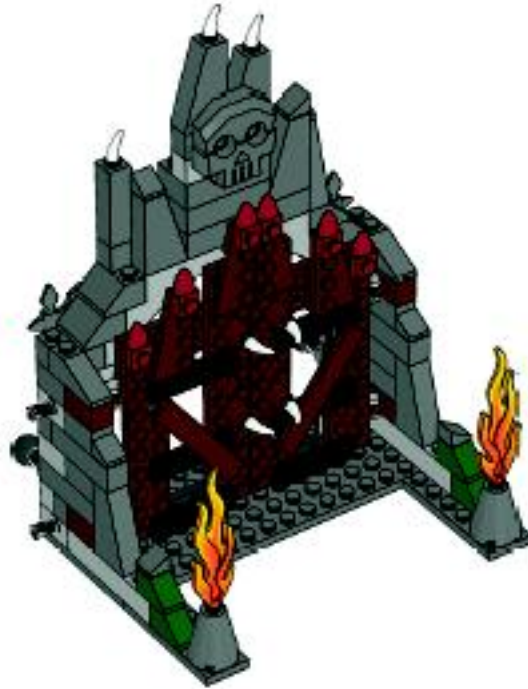

3

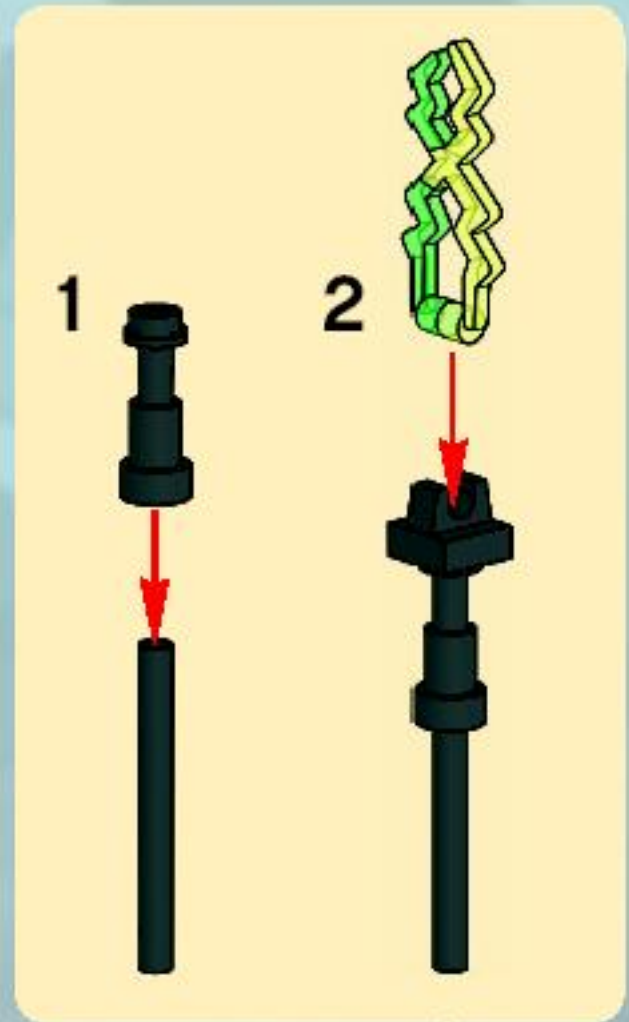
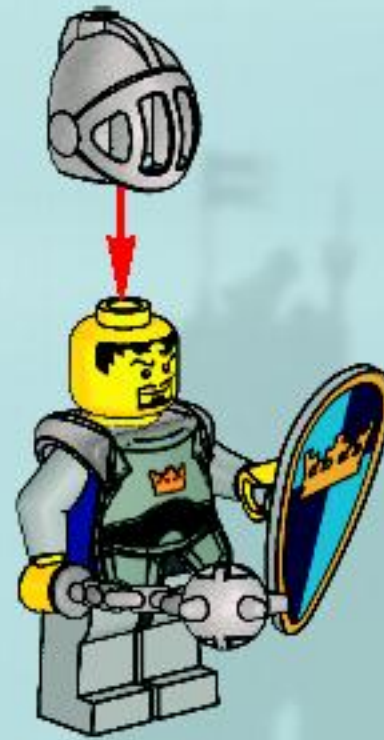



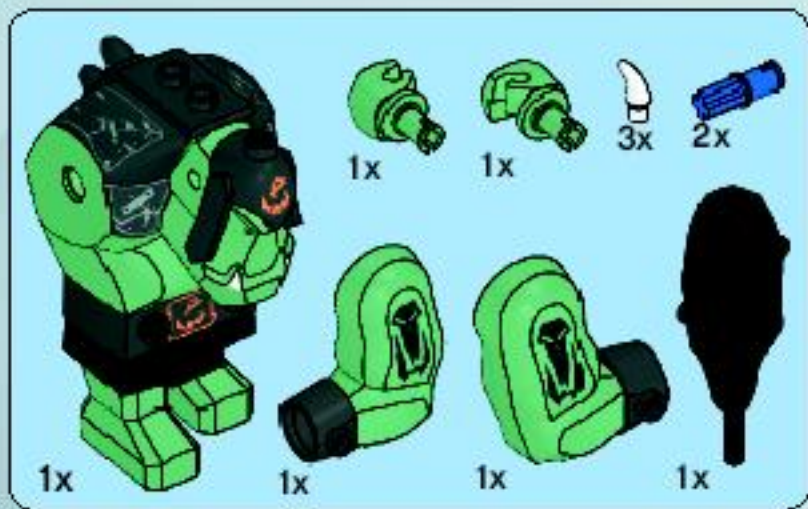

1



2

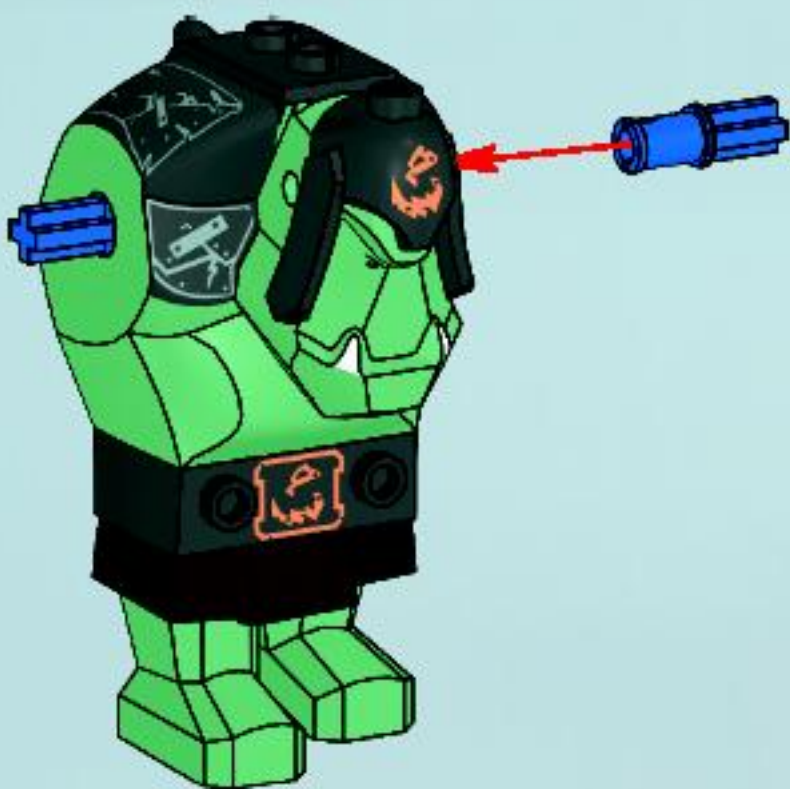

3



4



5

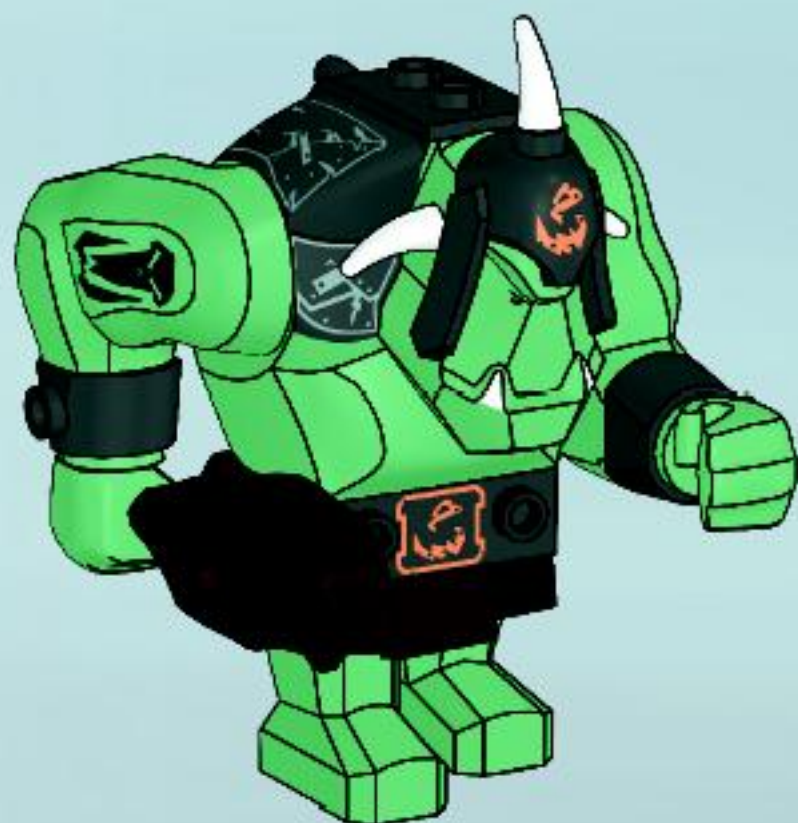



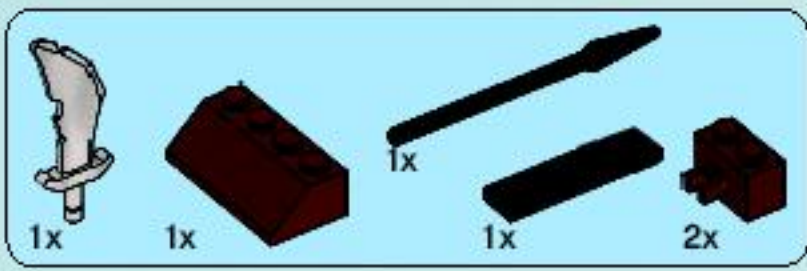

1

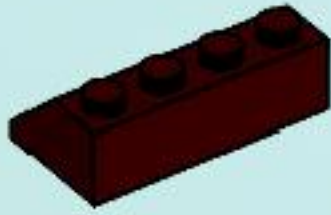

2

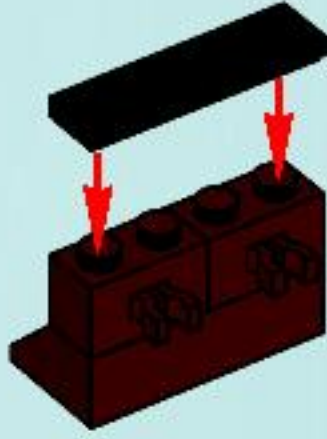

3

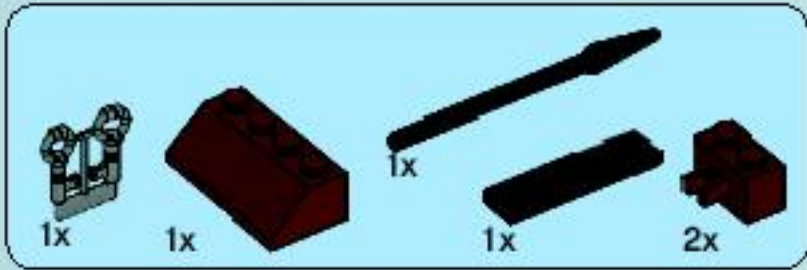

1



2

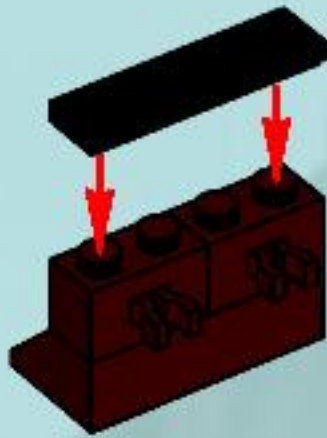

3





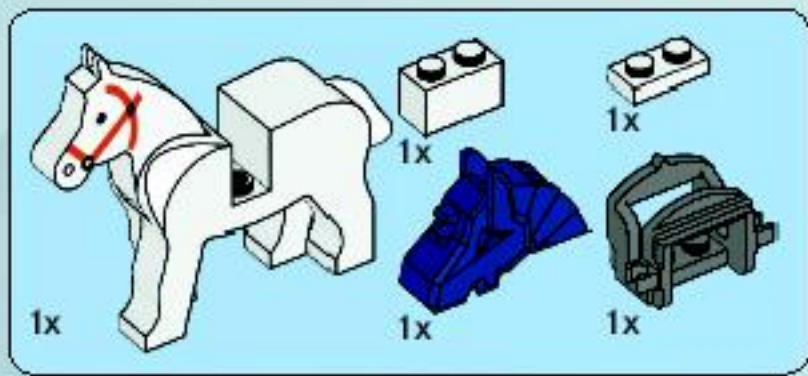

1

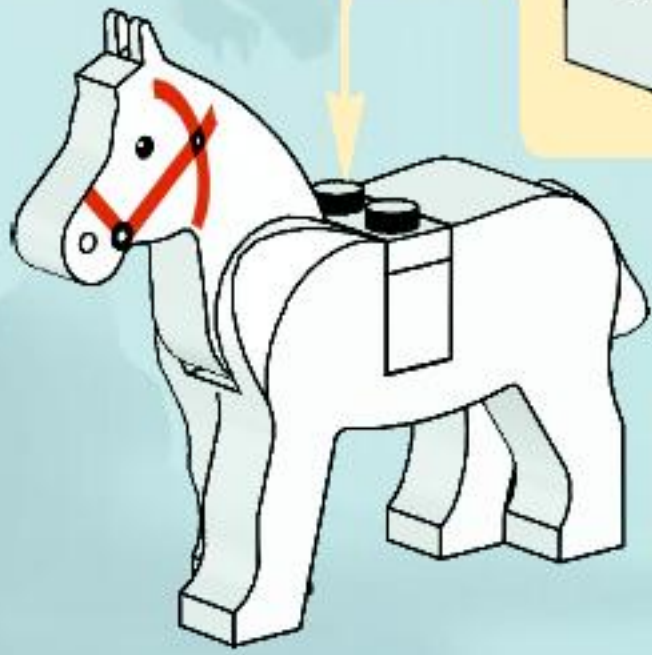

2

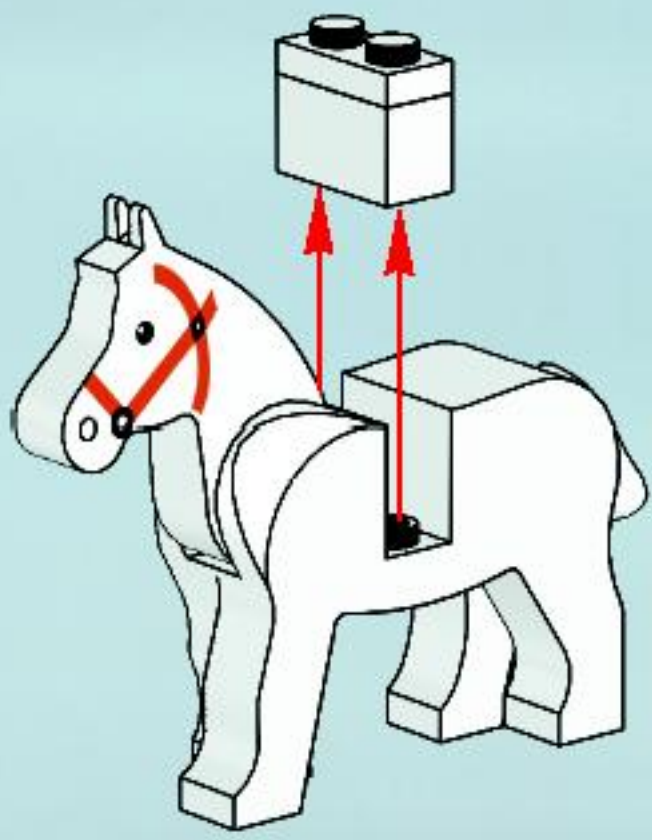

3

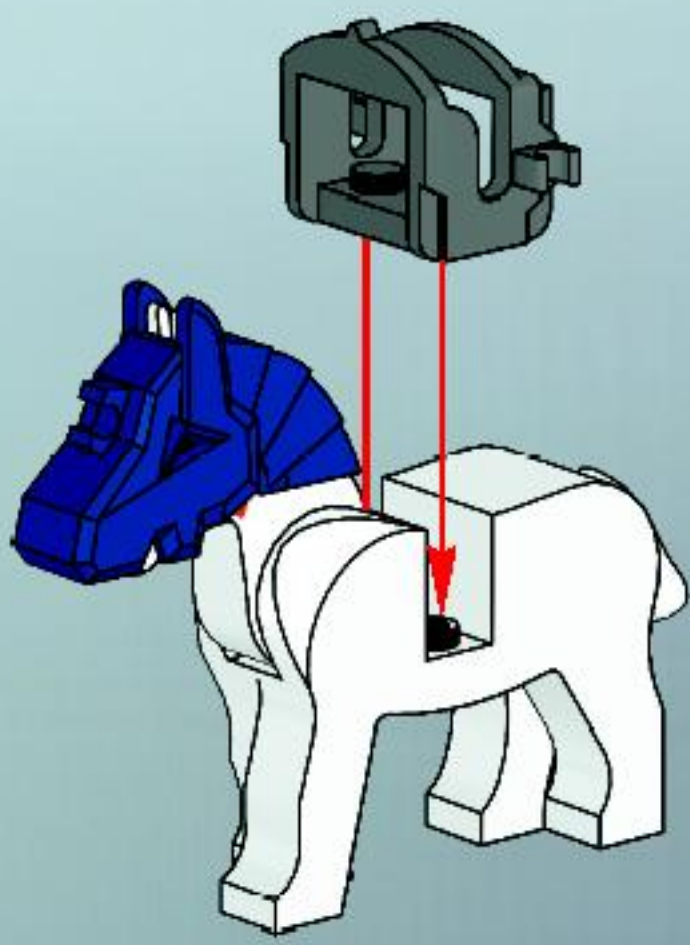



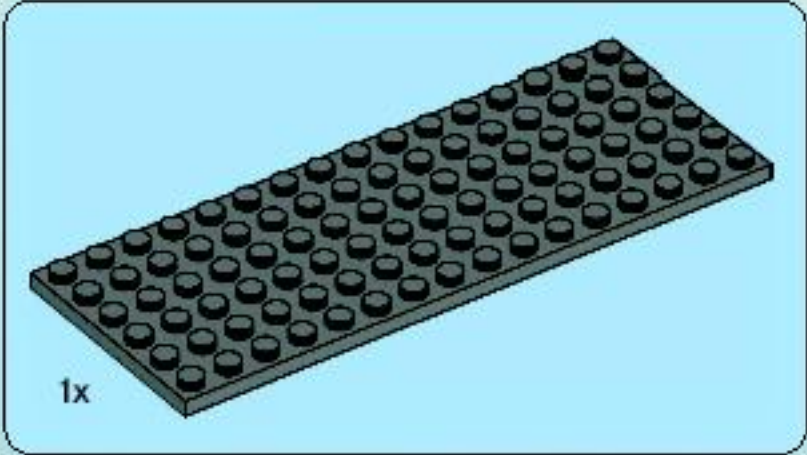

1

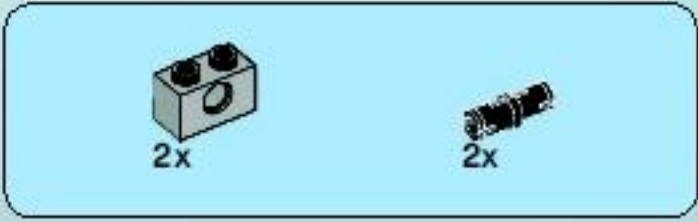
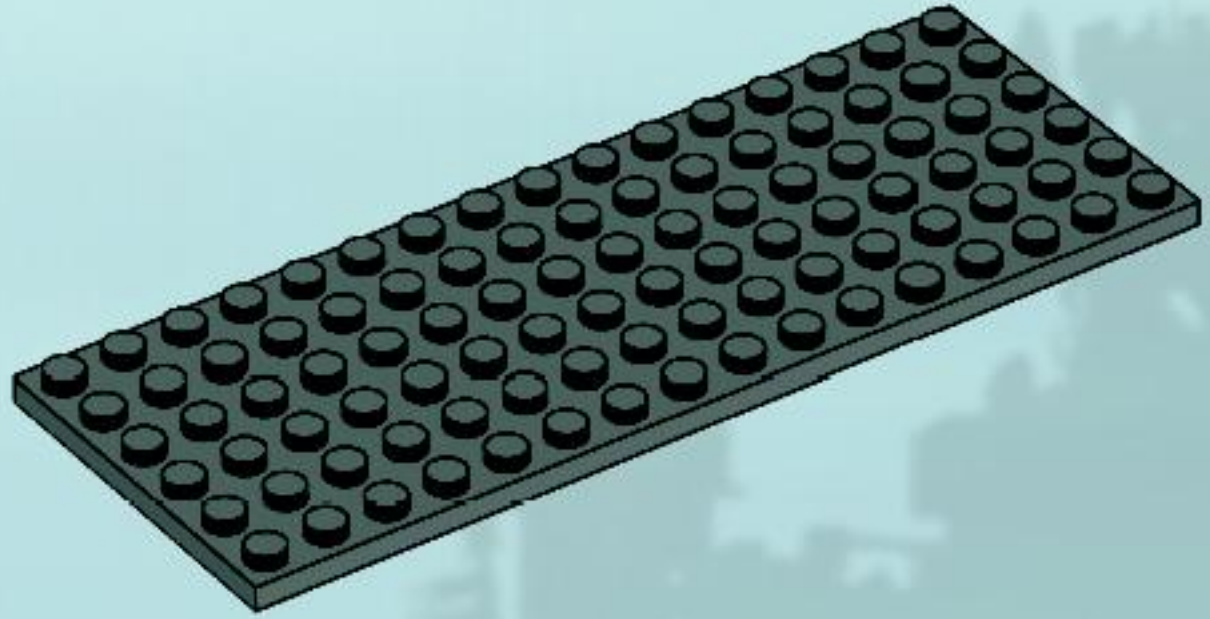

2

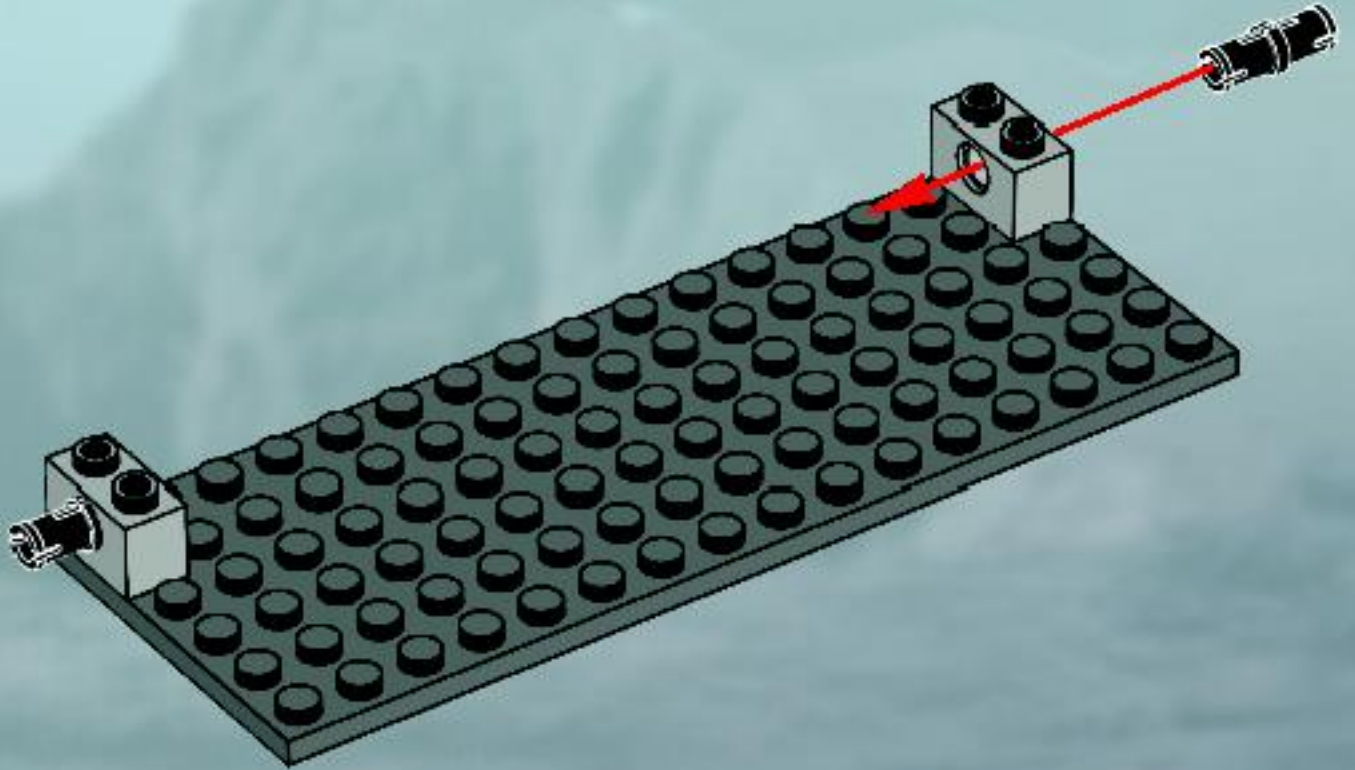



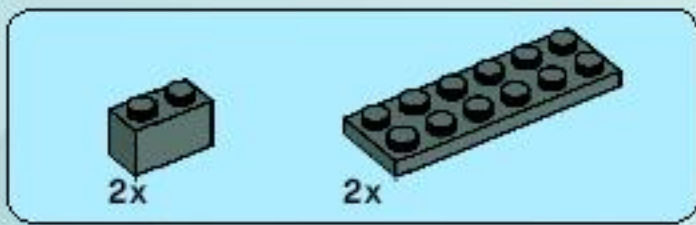

3

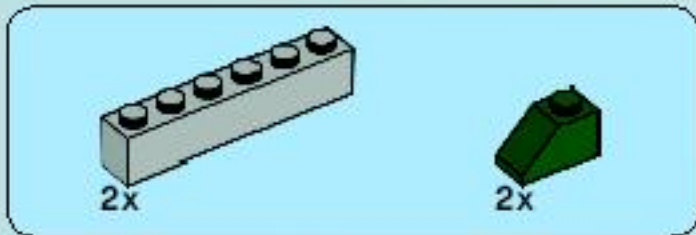
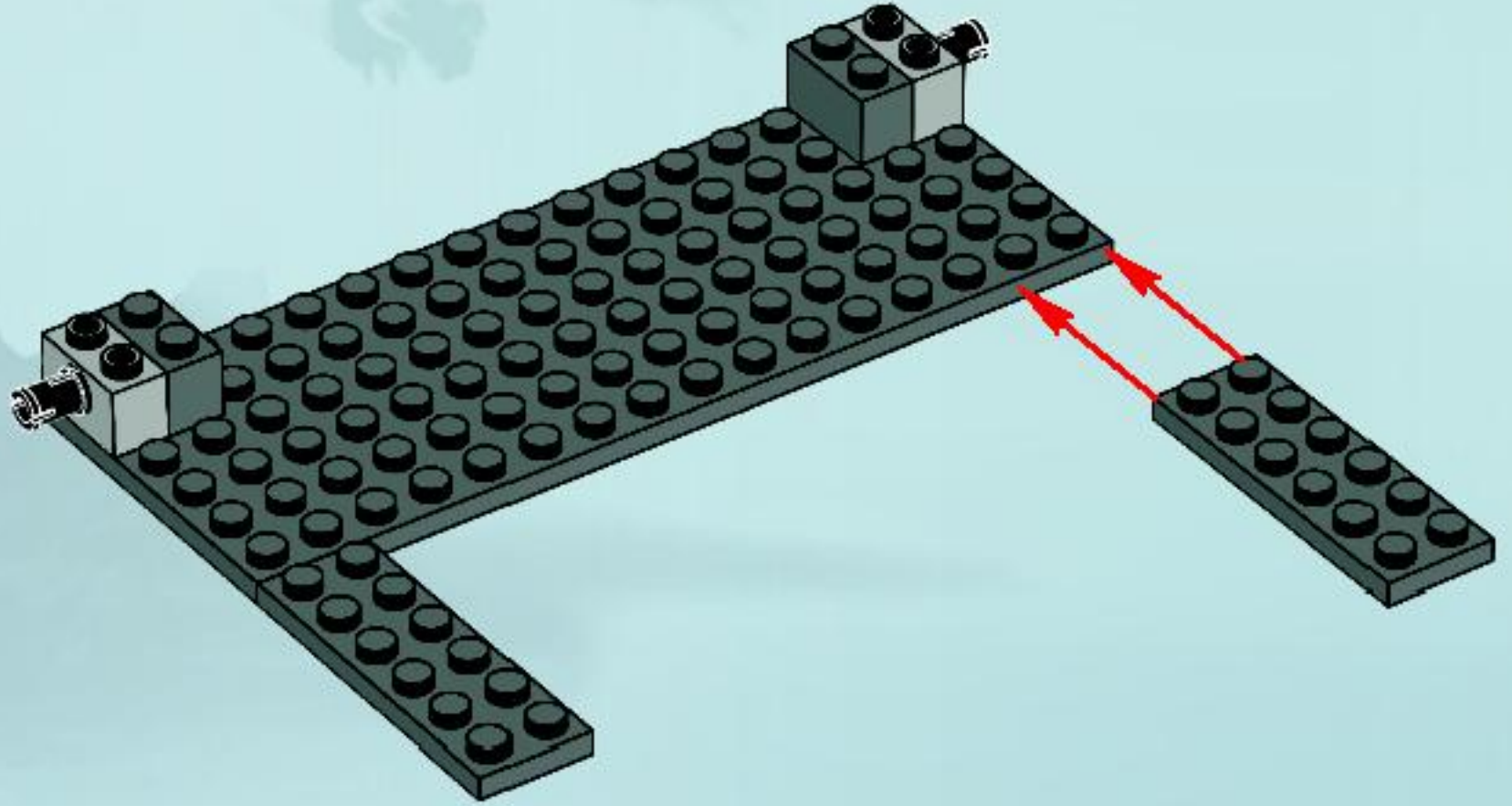

4

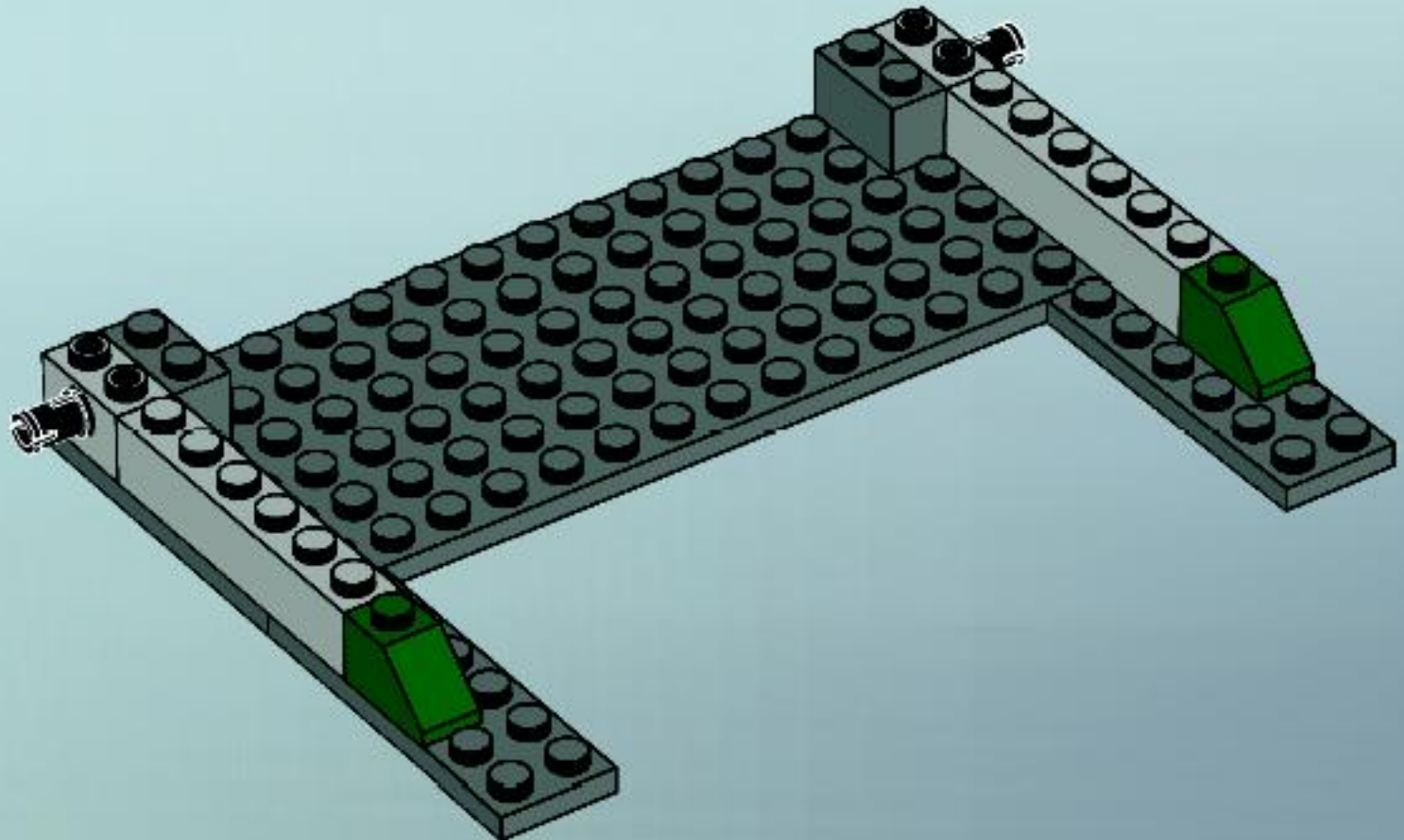



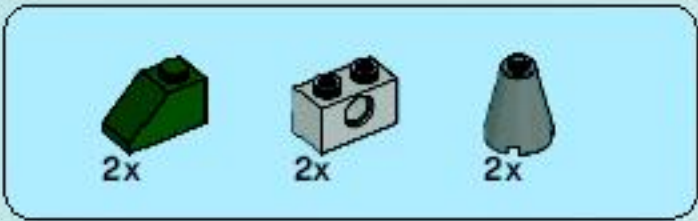

5

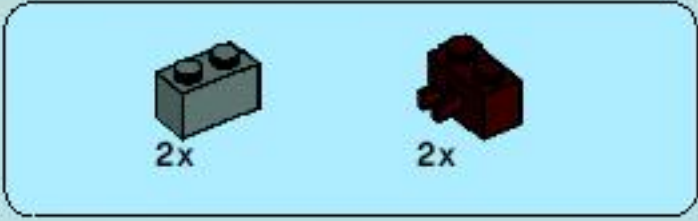
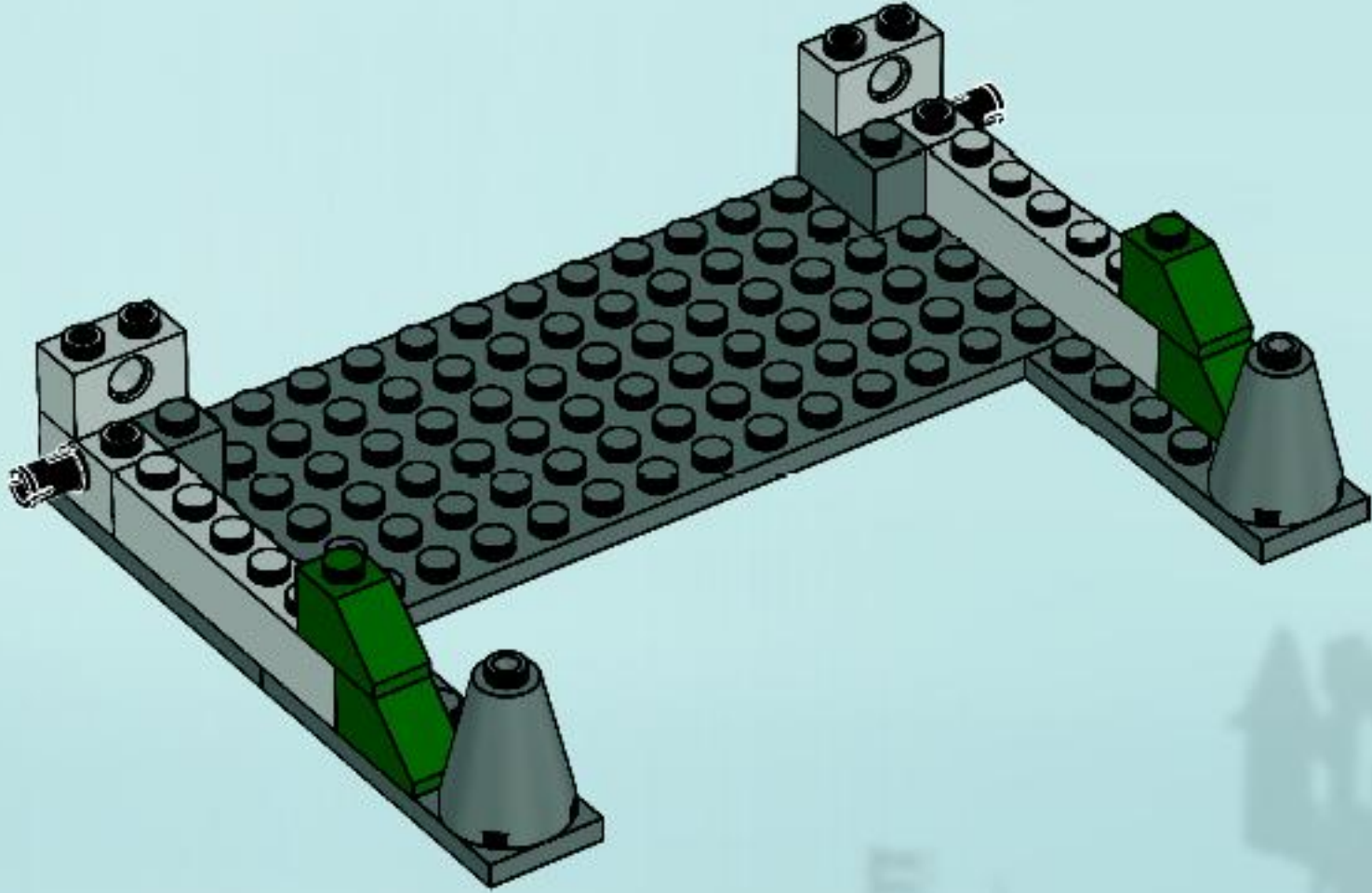

6

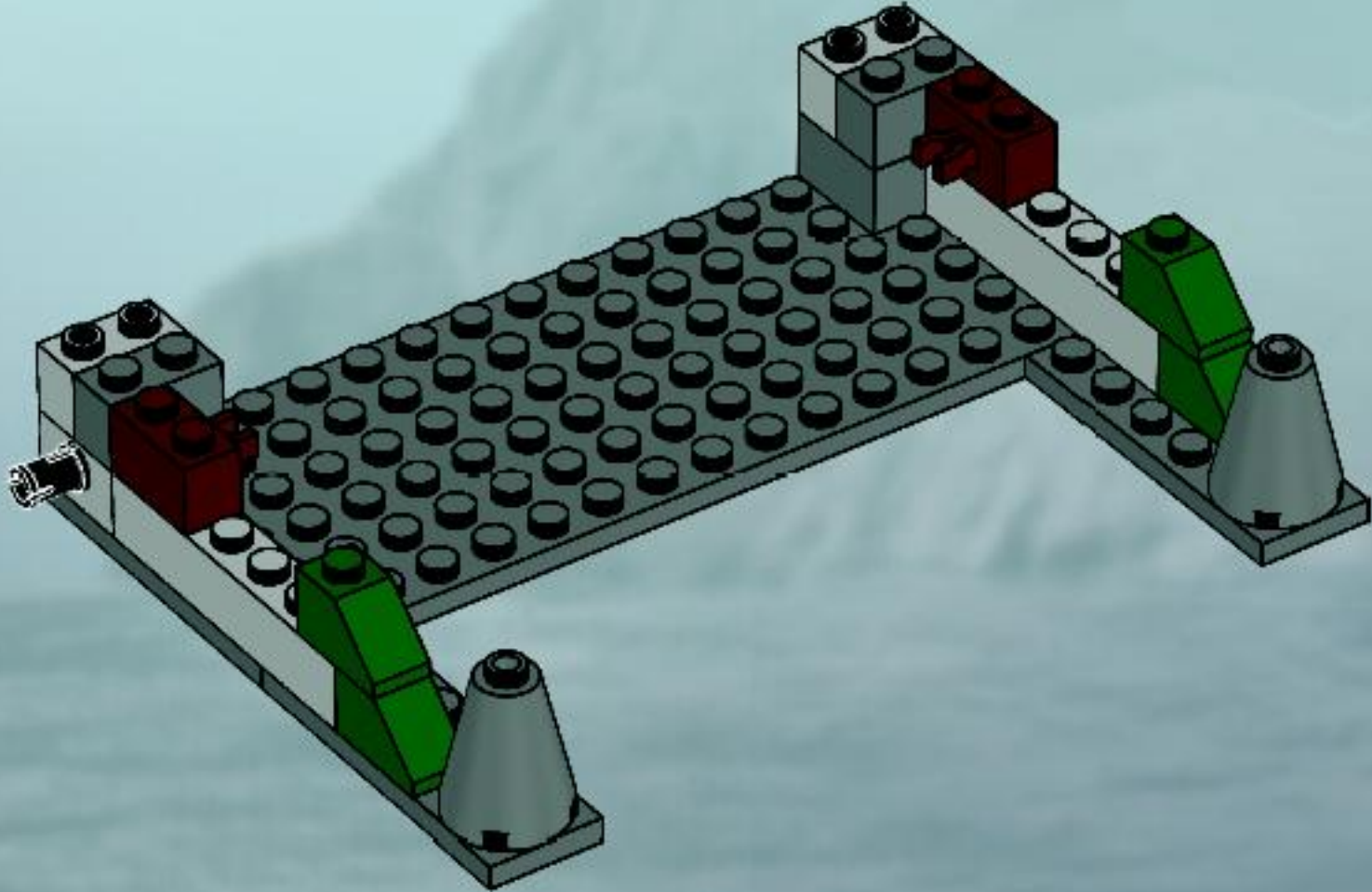



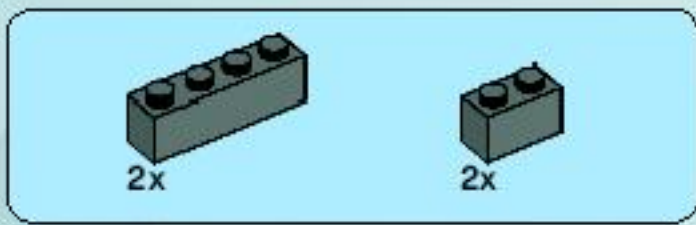

7

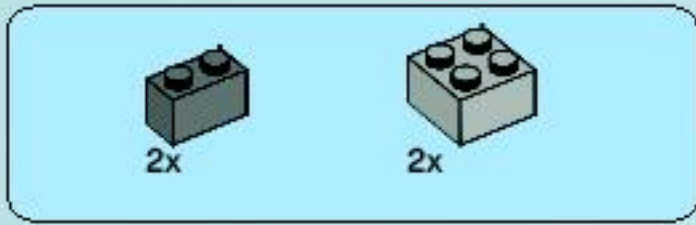
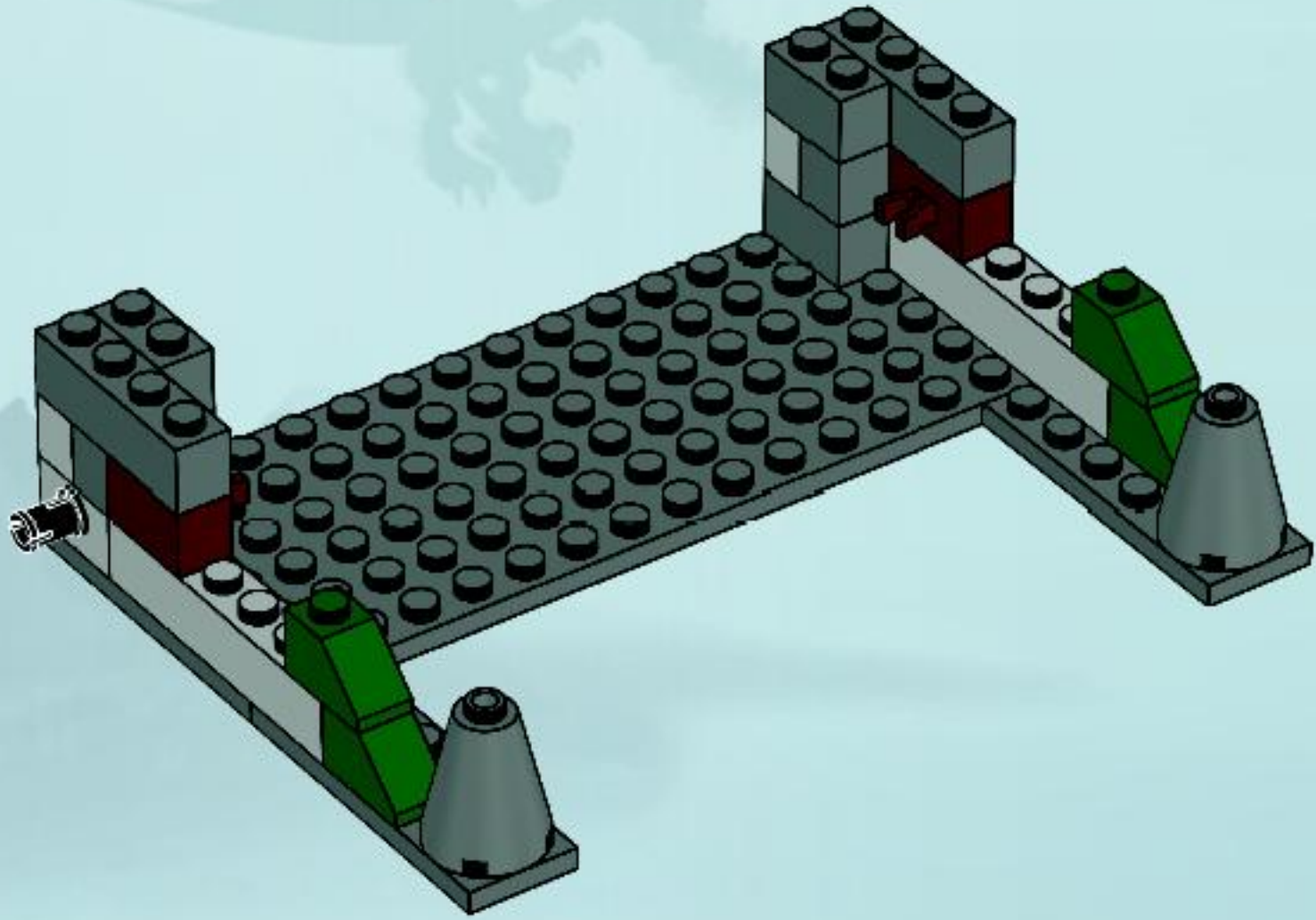

8

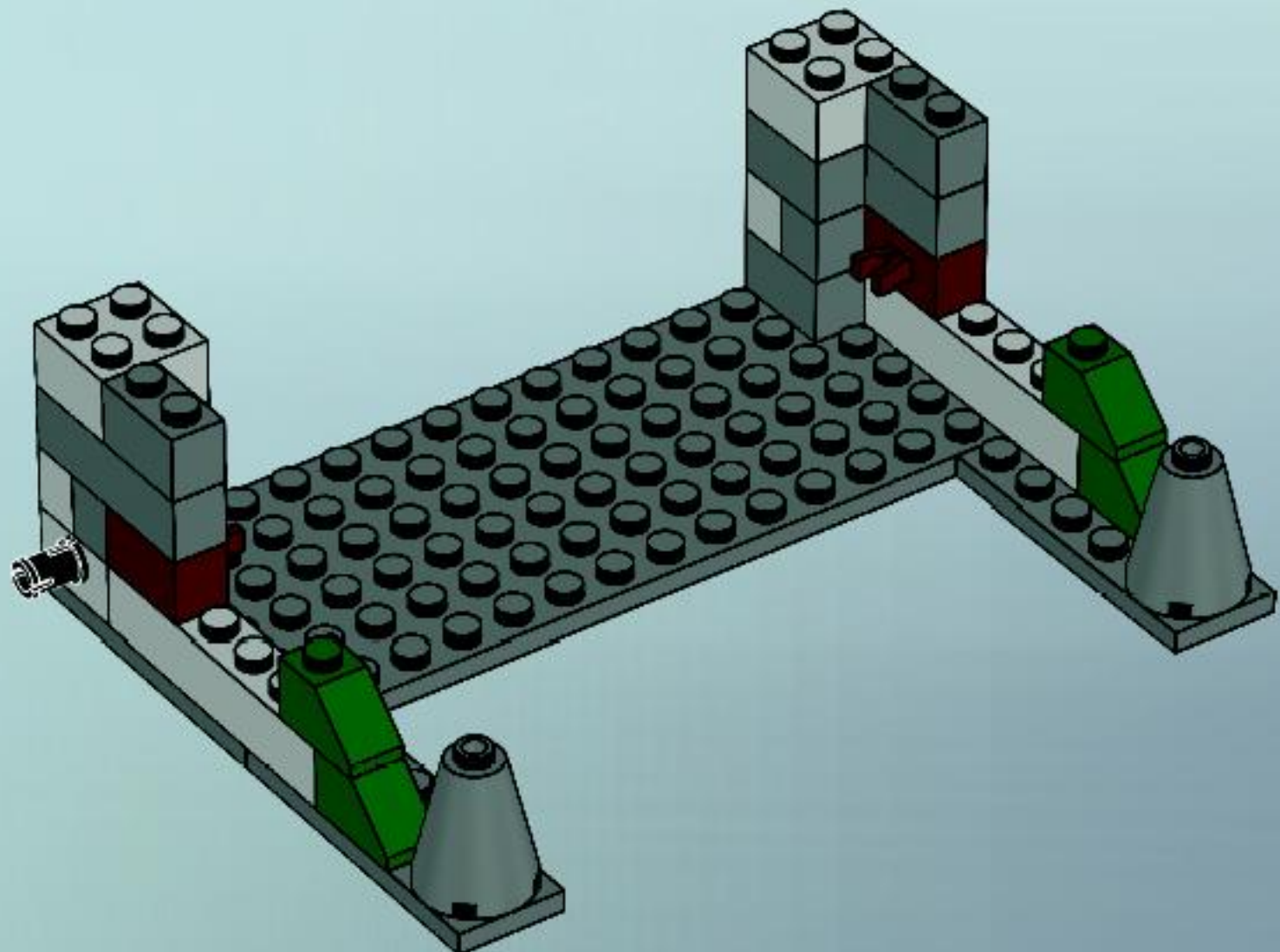



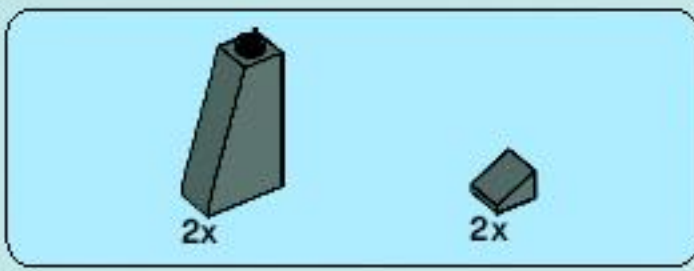

9

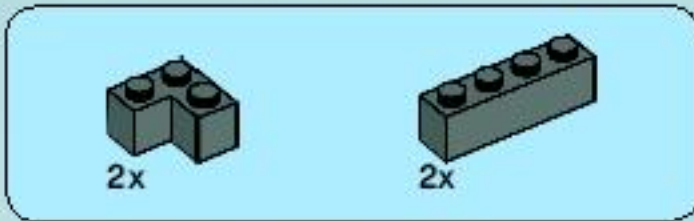
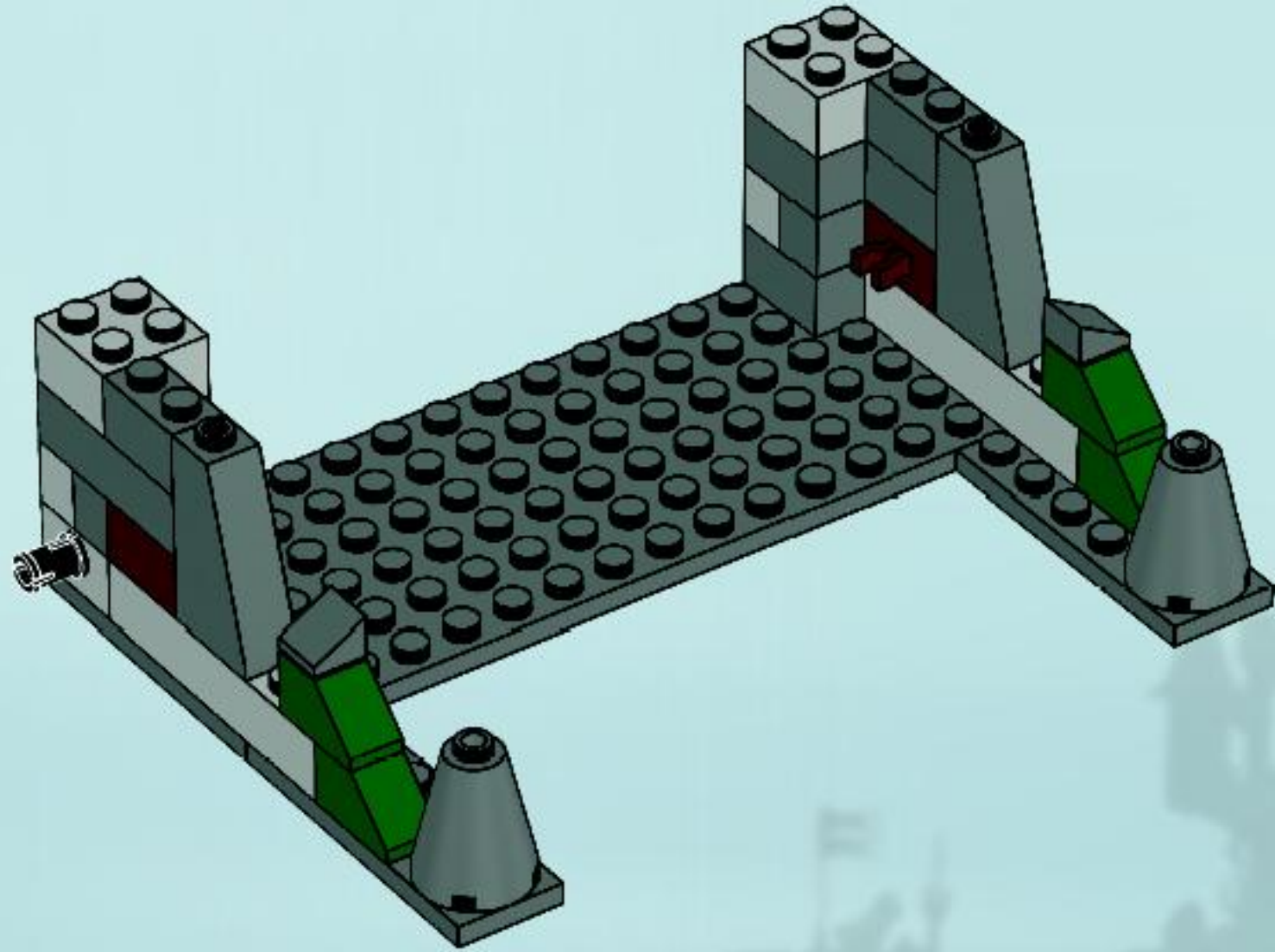

10

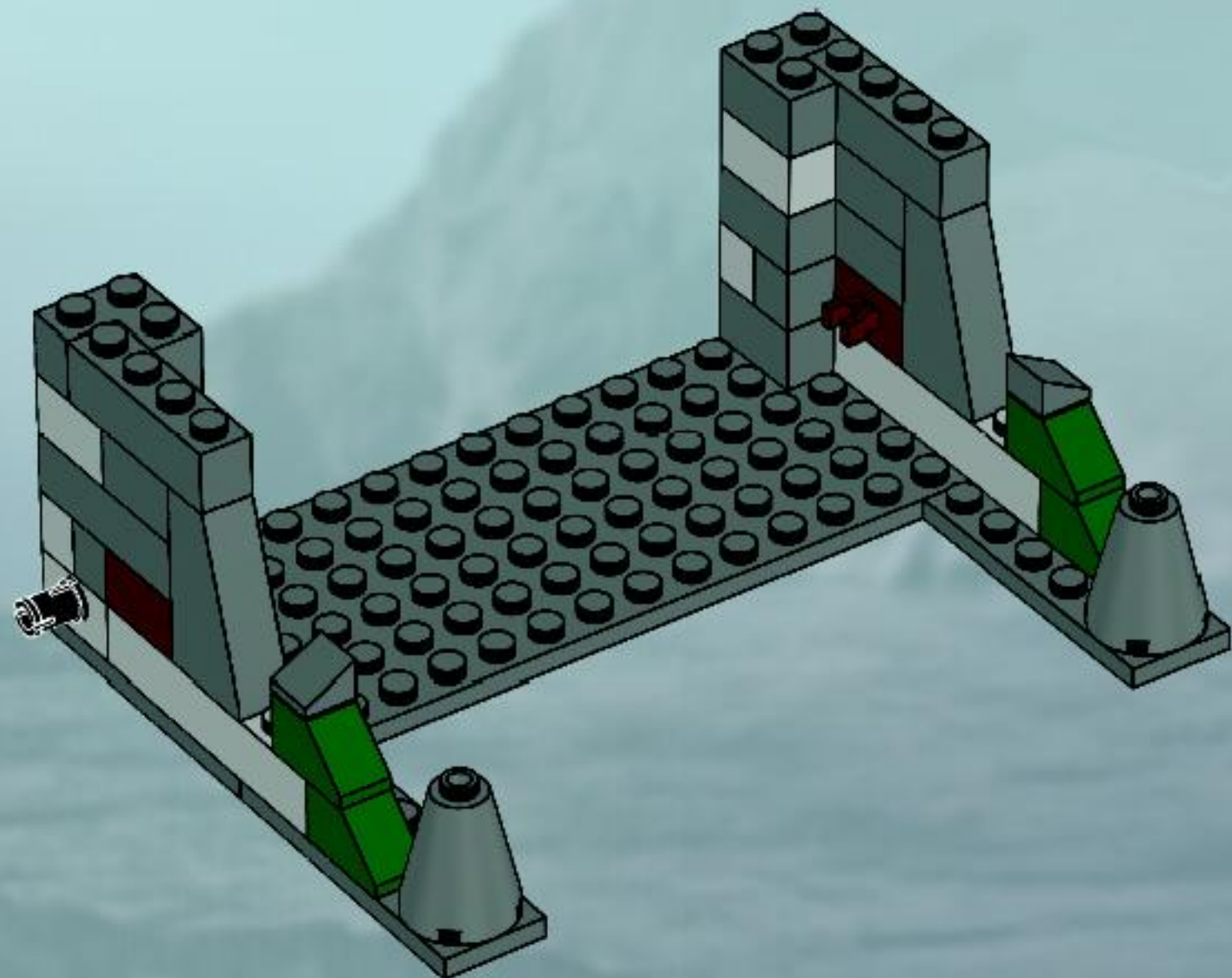



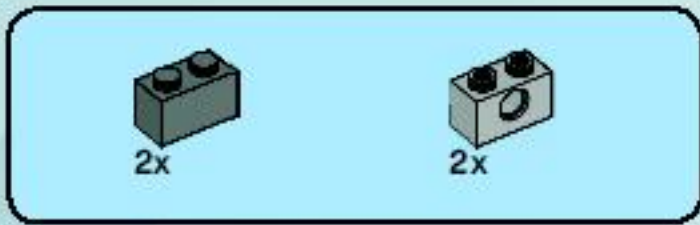

11

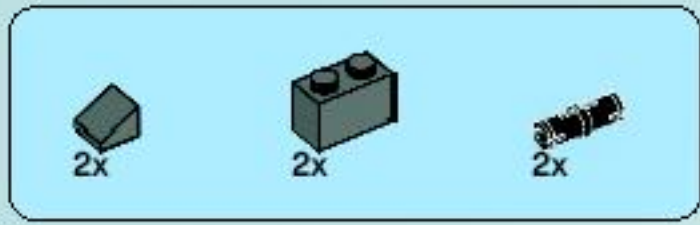
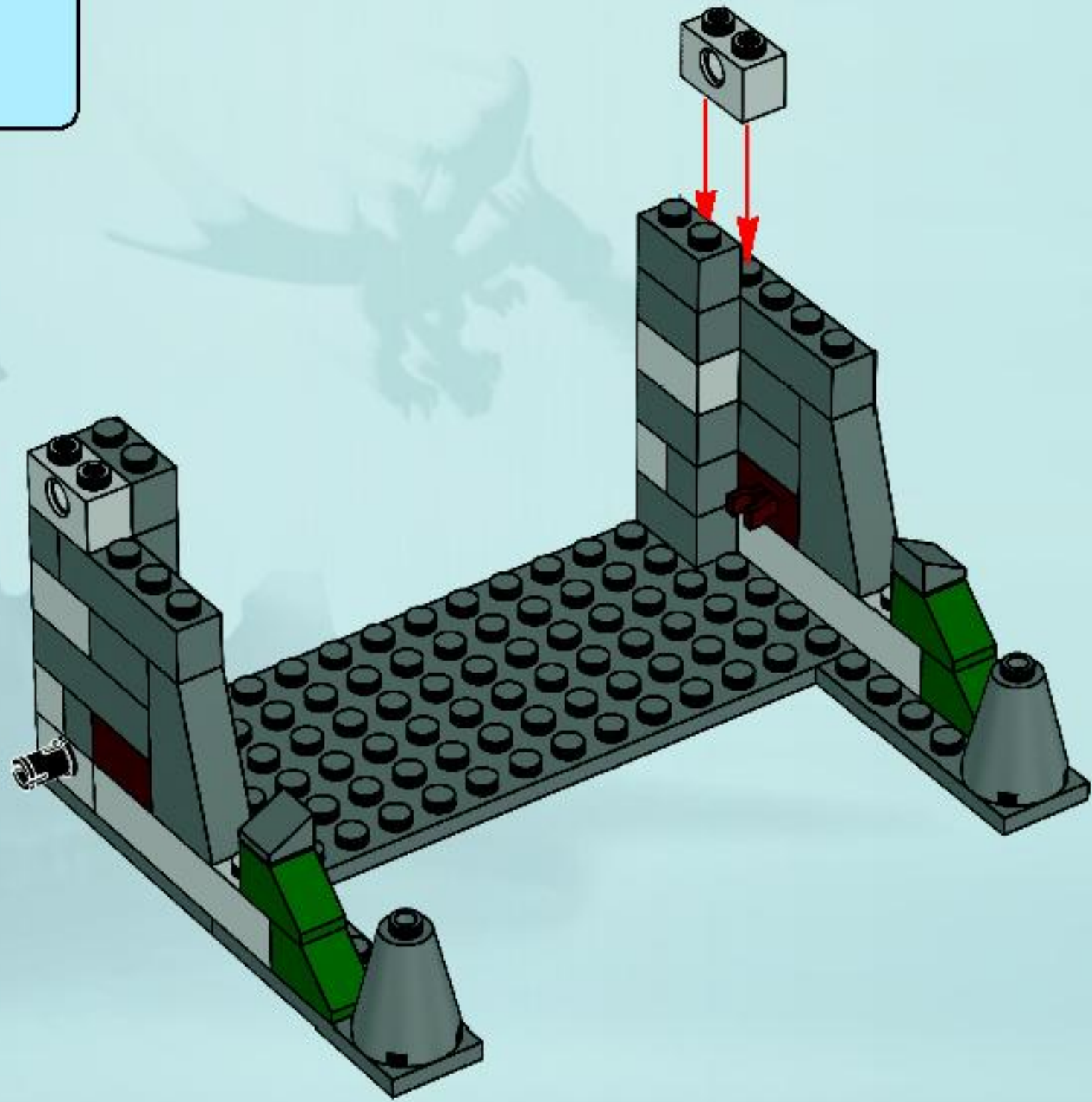

12

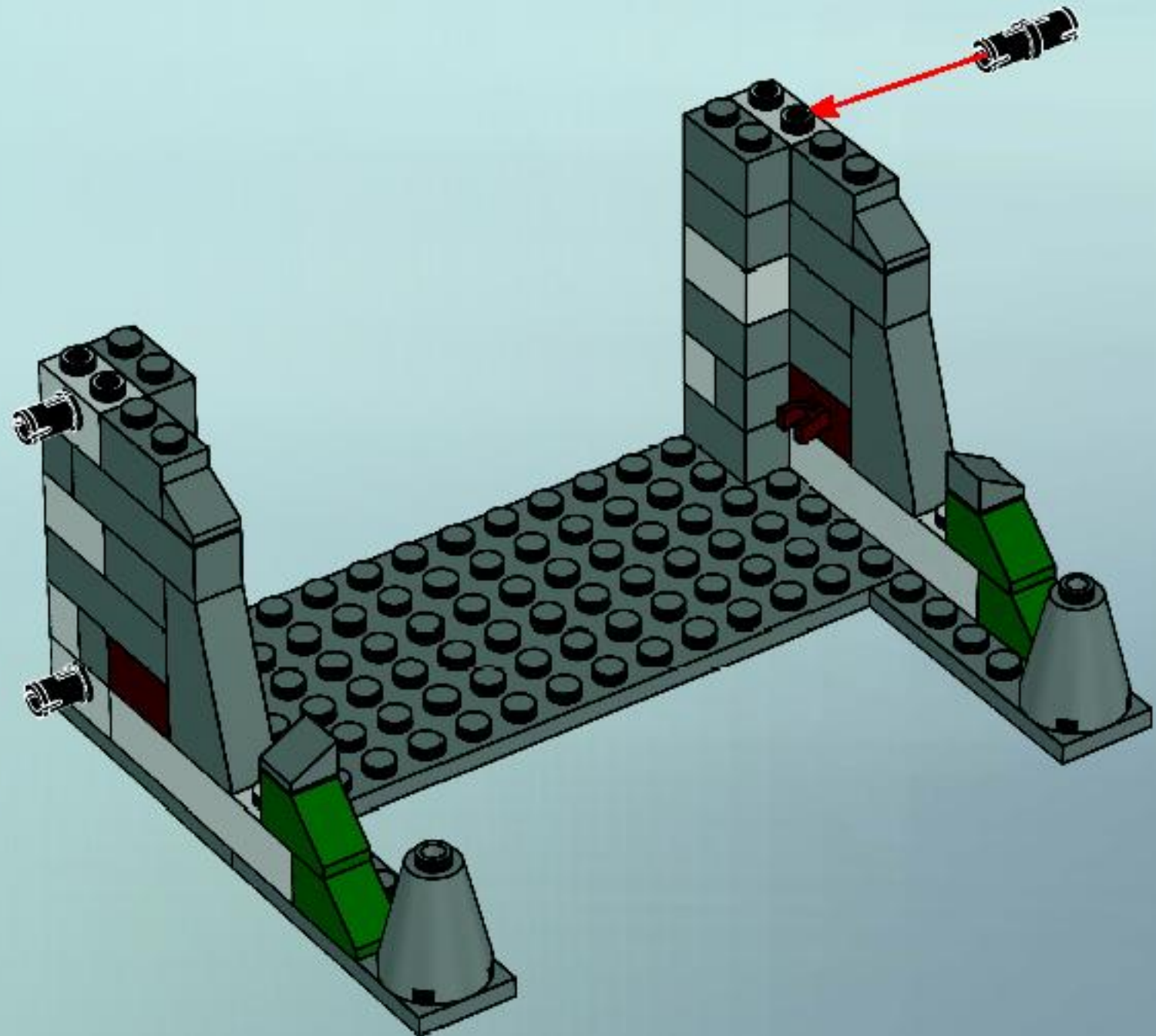



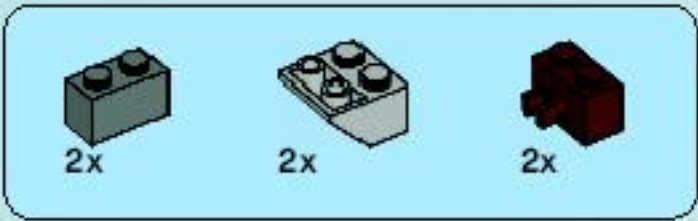

# 13

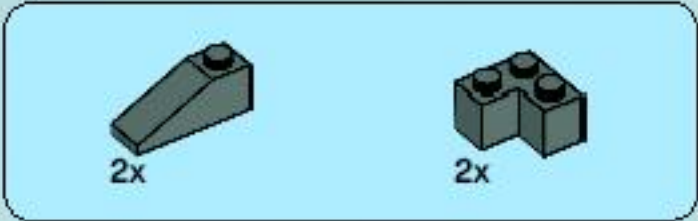
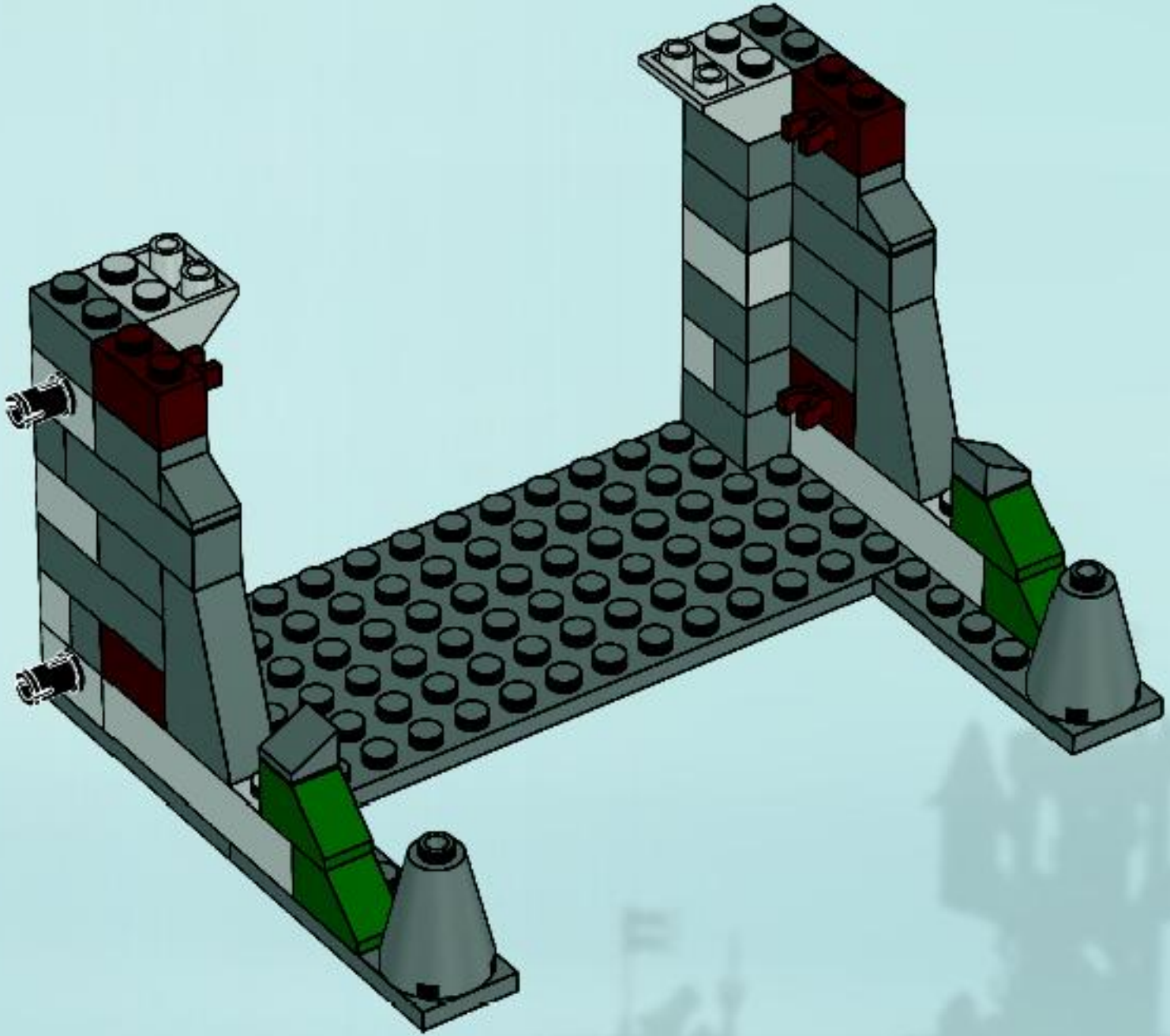

# 14

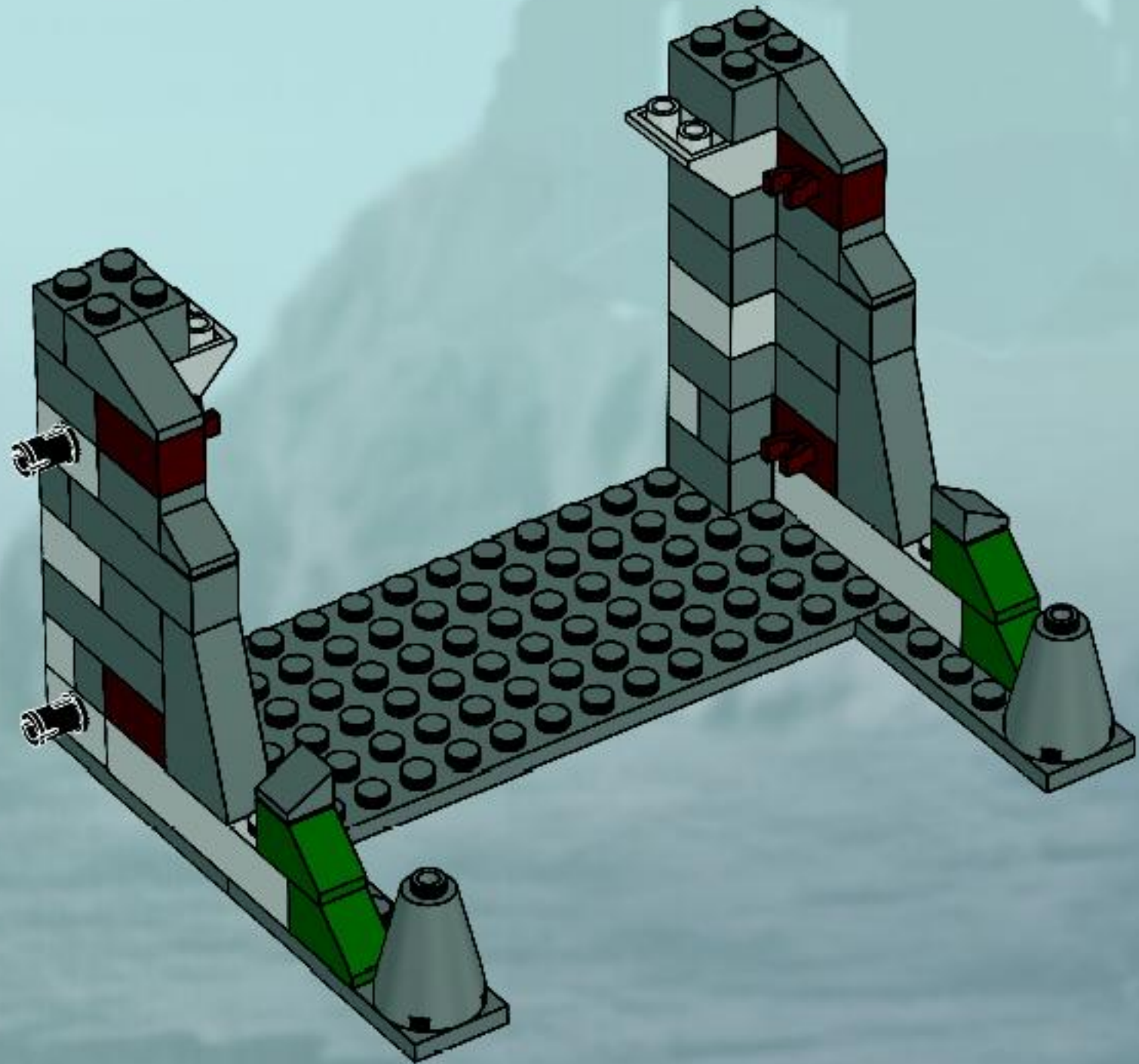



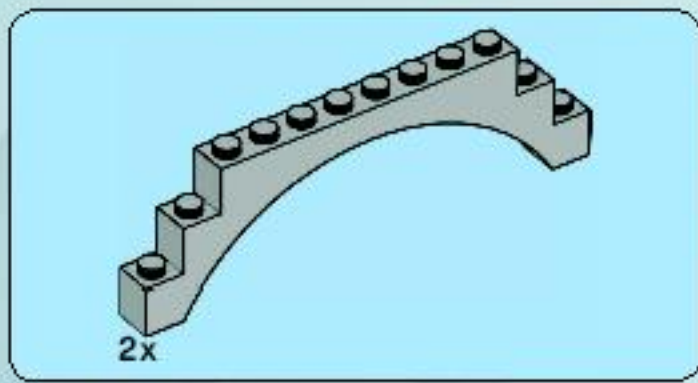

15

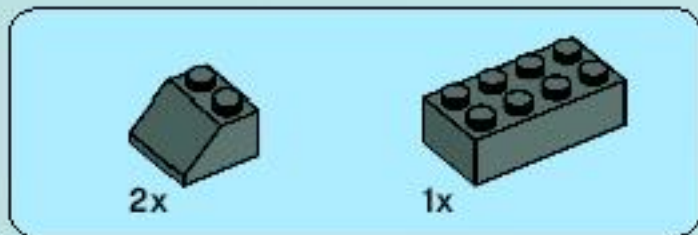
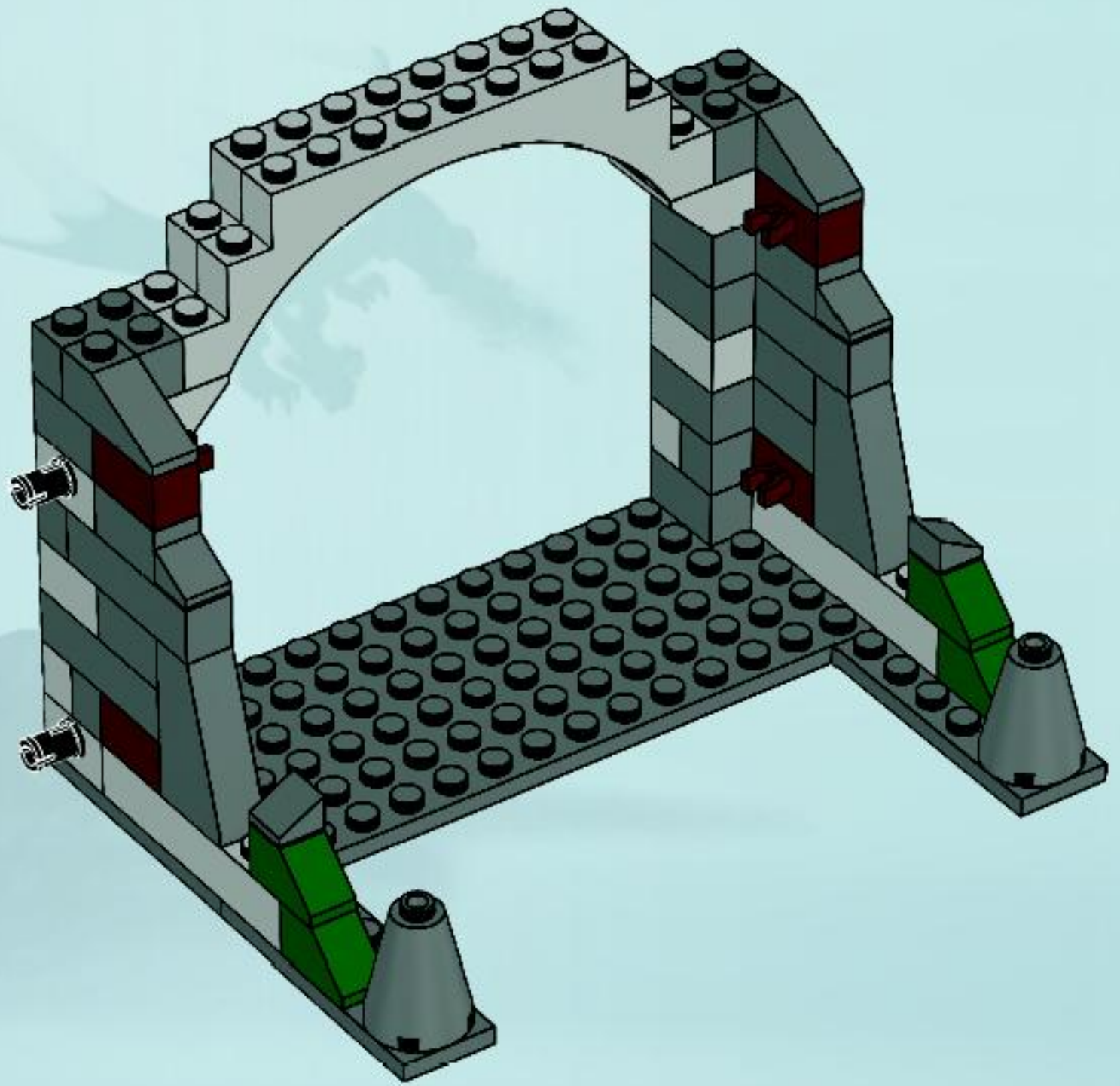

16

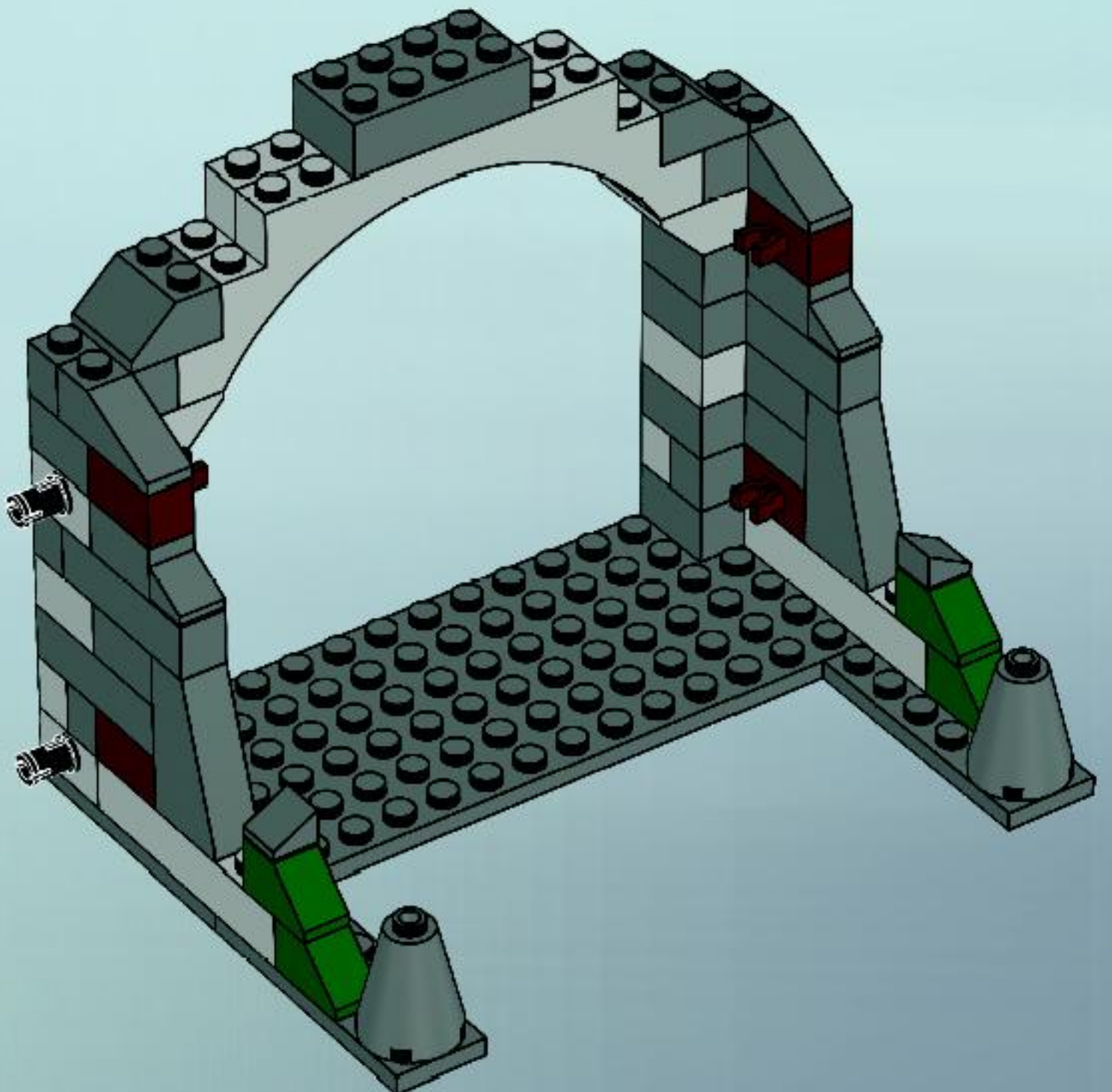



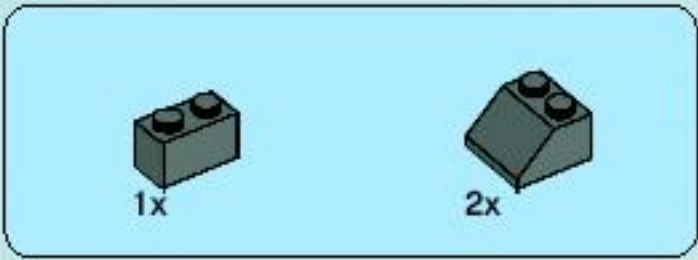

17

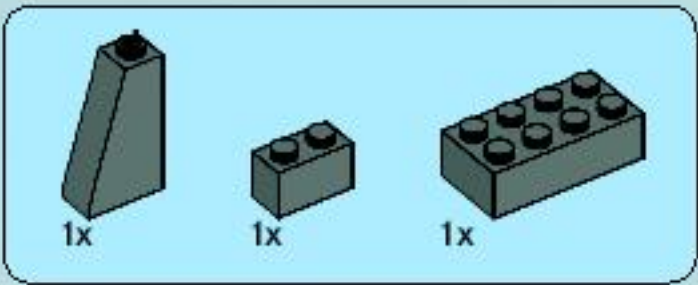
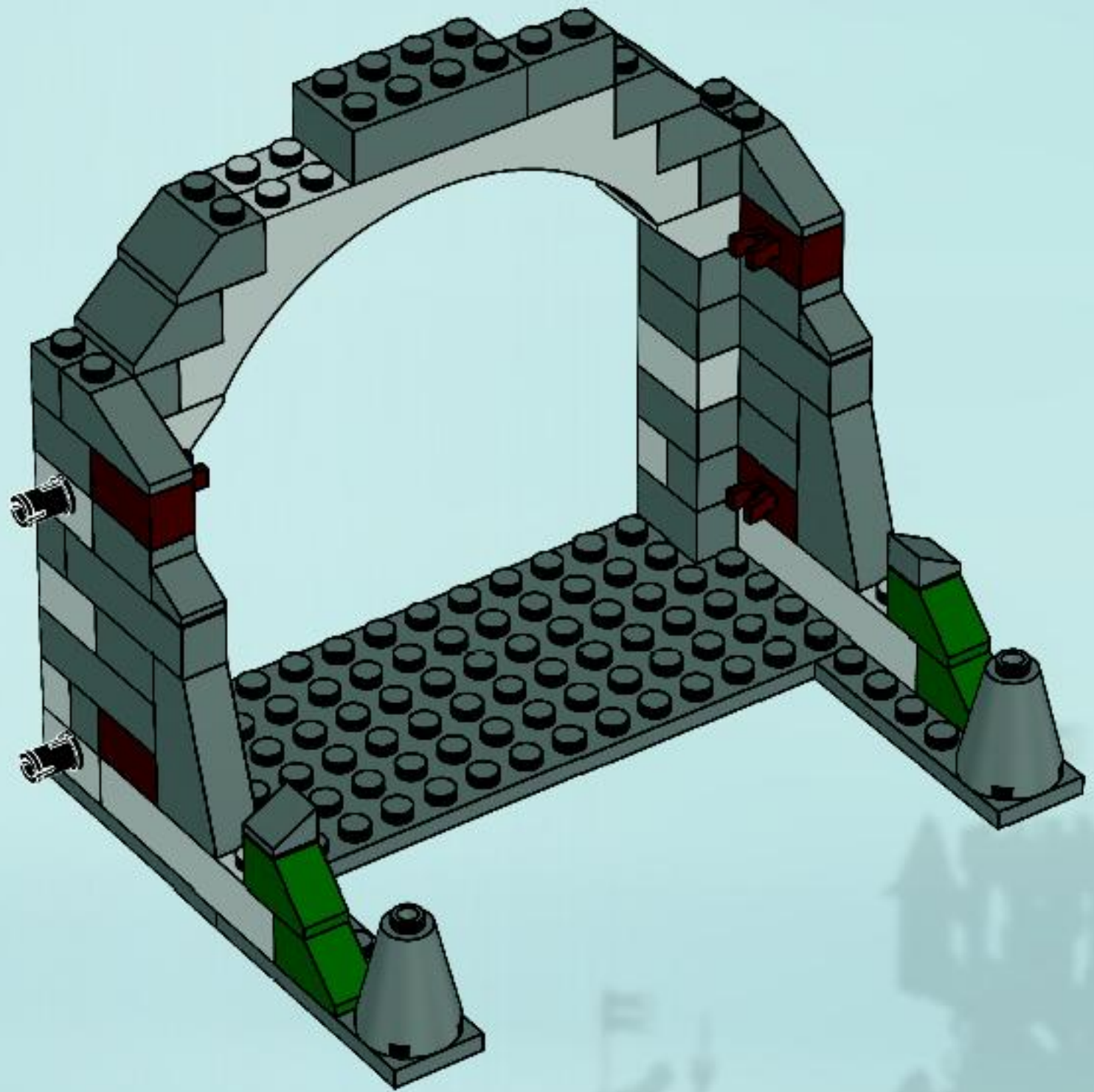

18

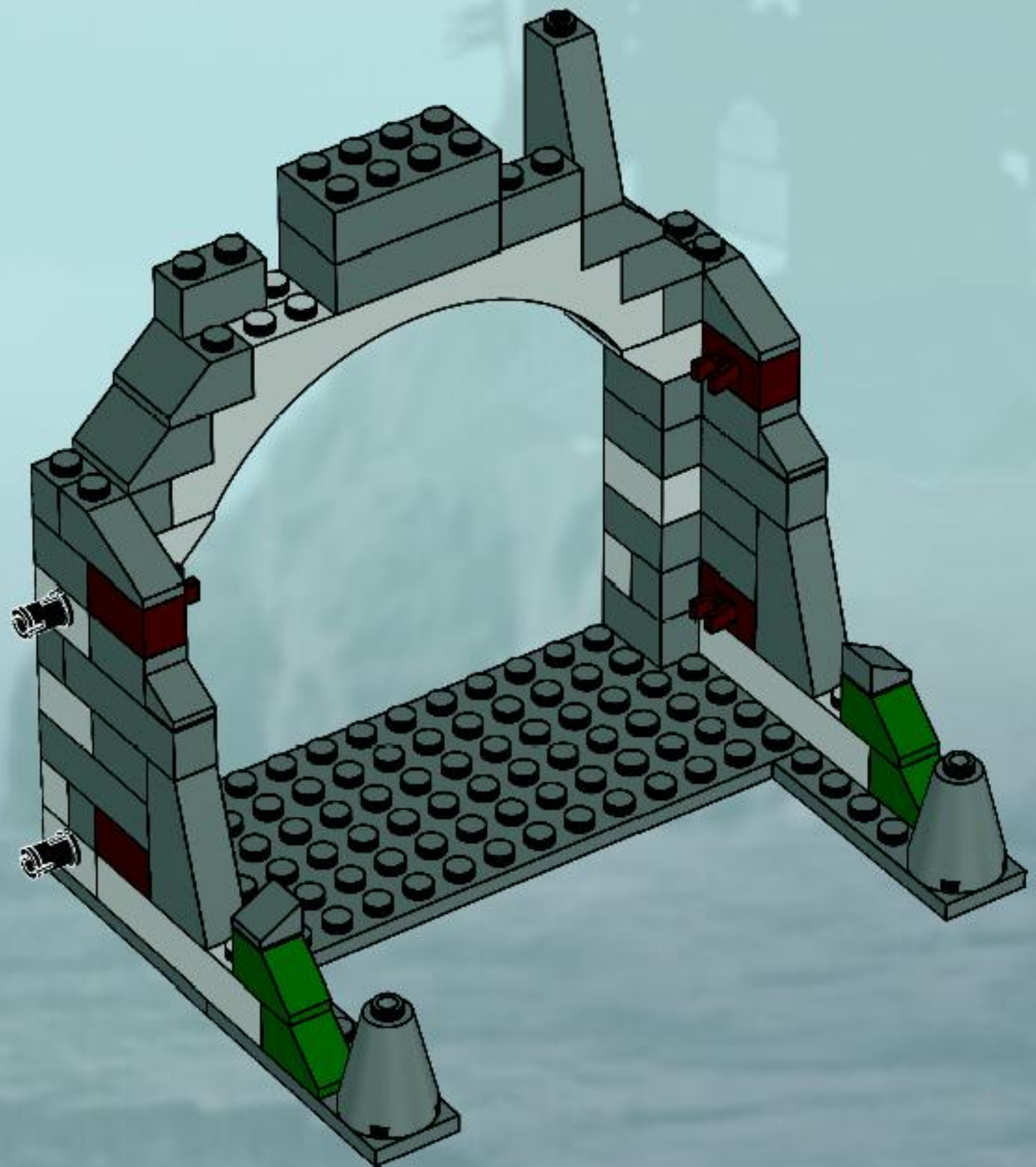



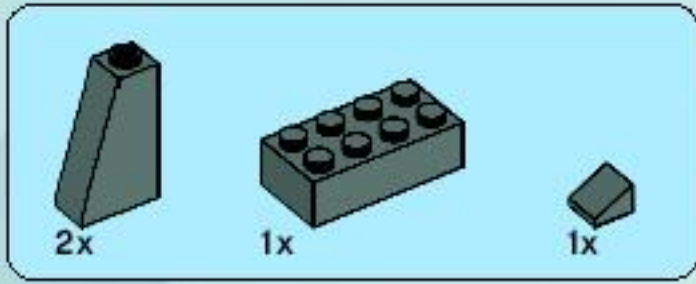

19

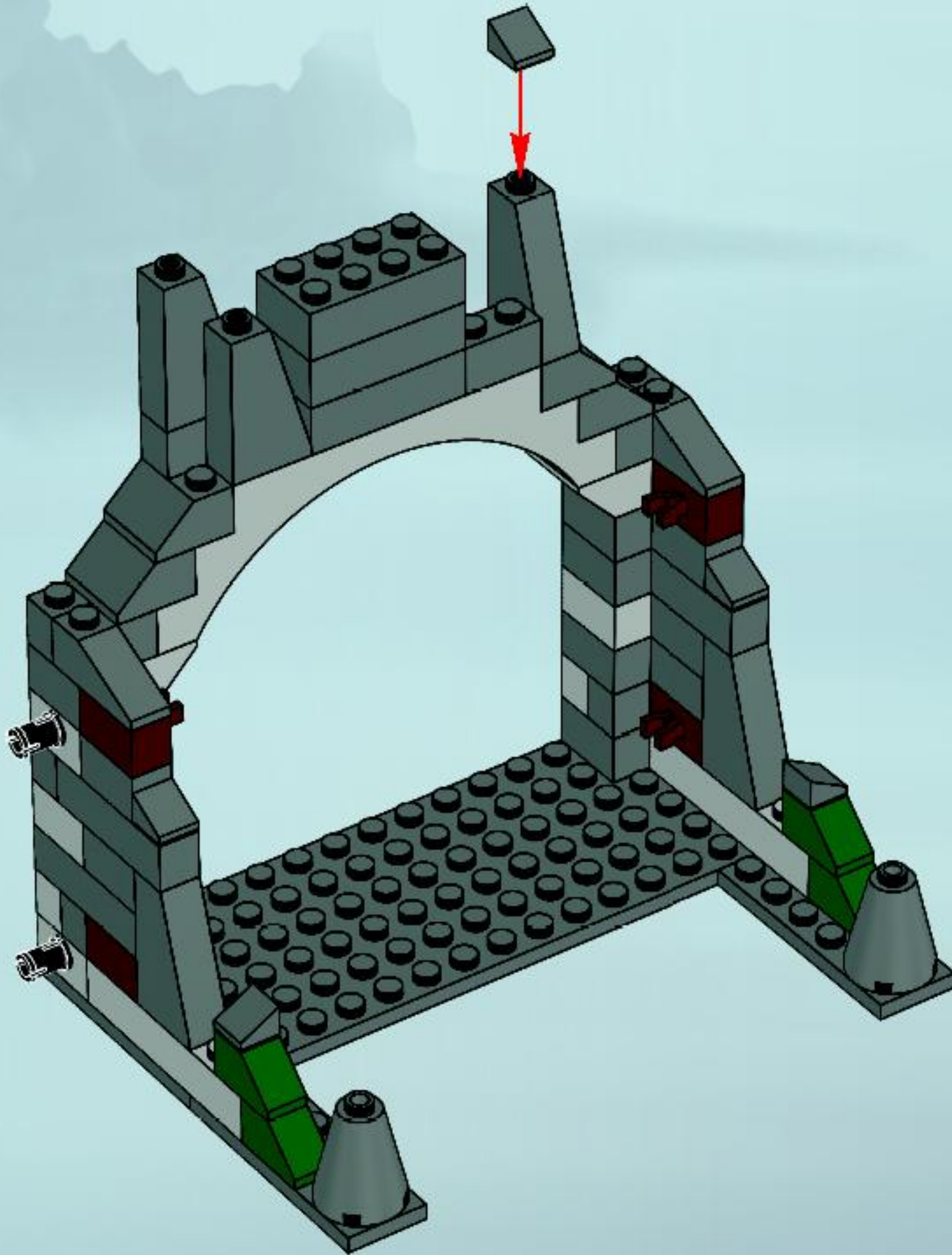



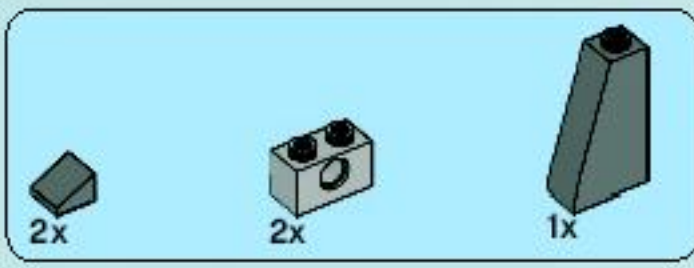

20

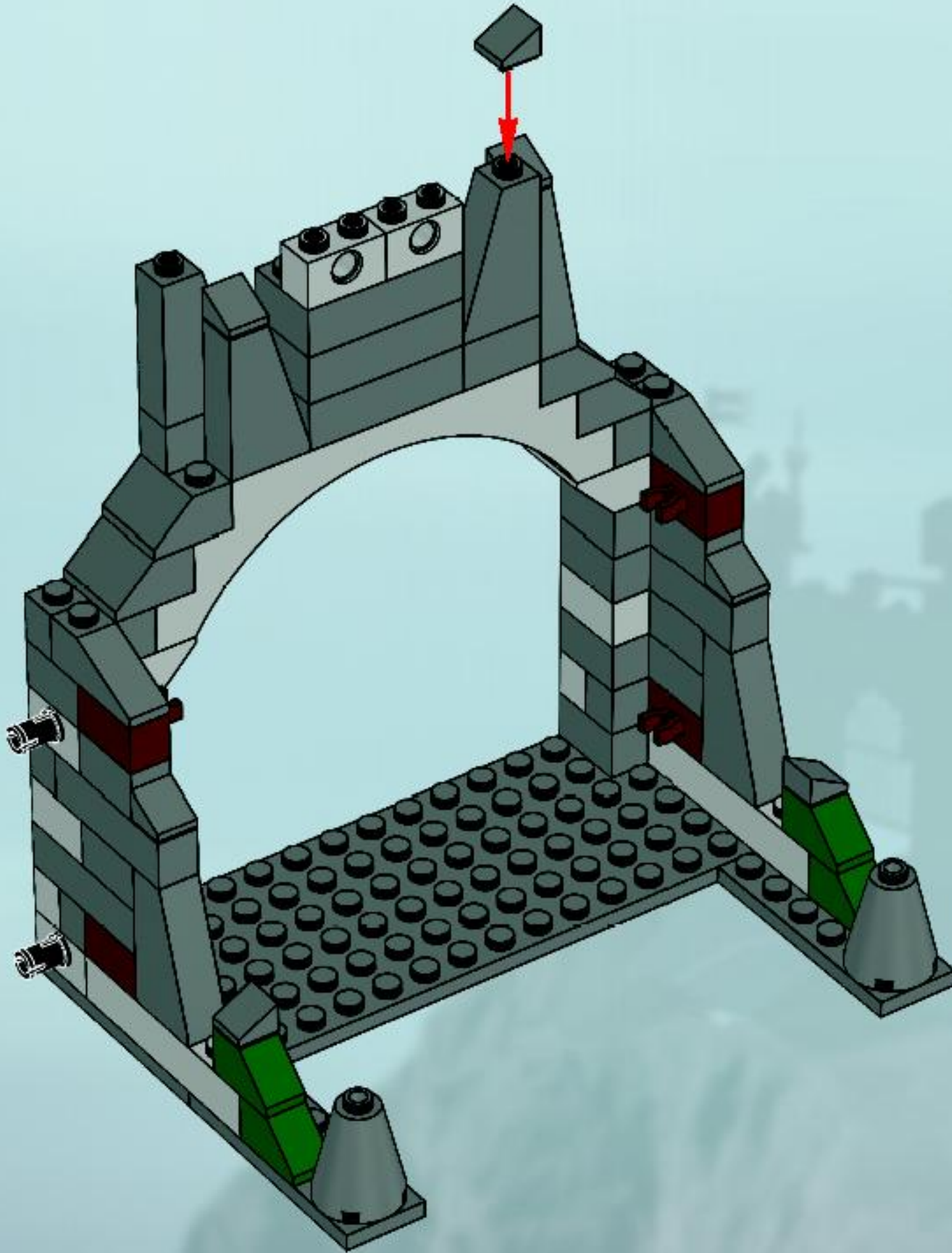



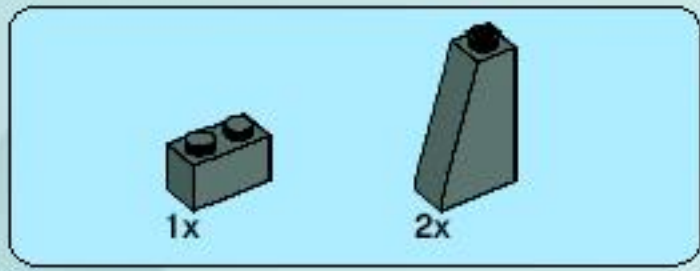

21

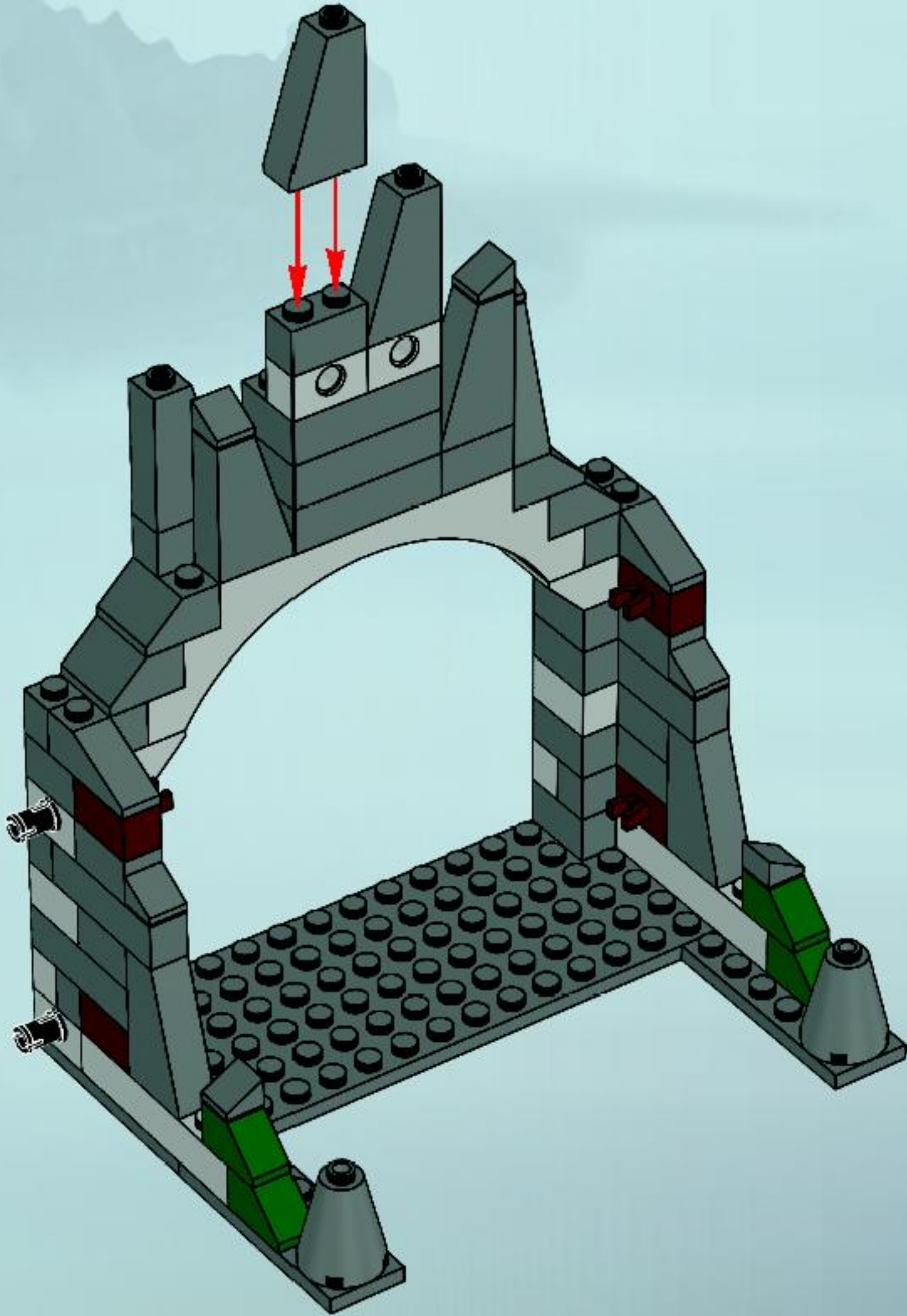



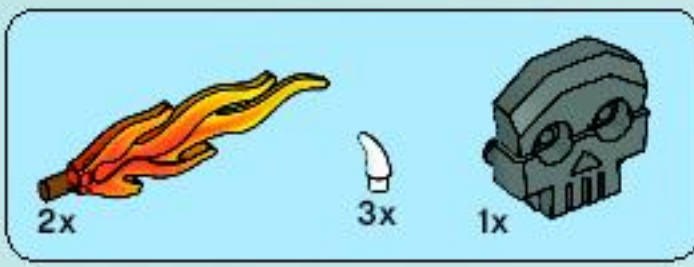

22





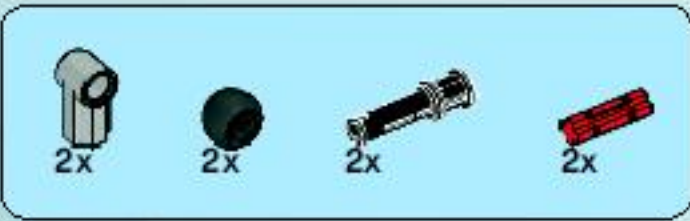

# 23

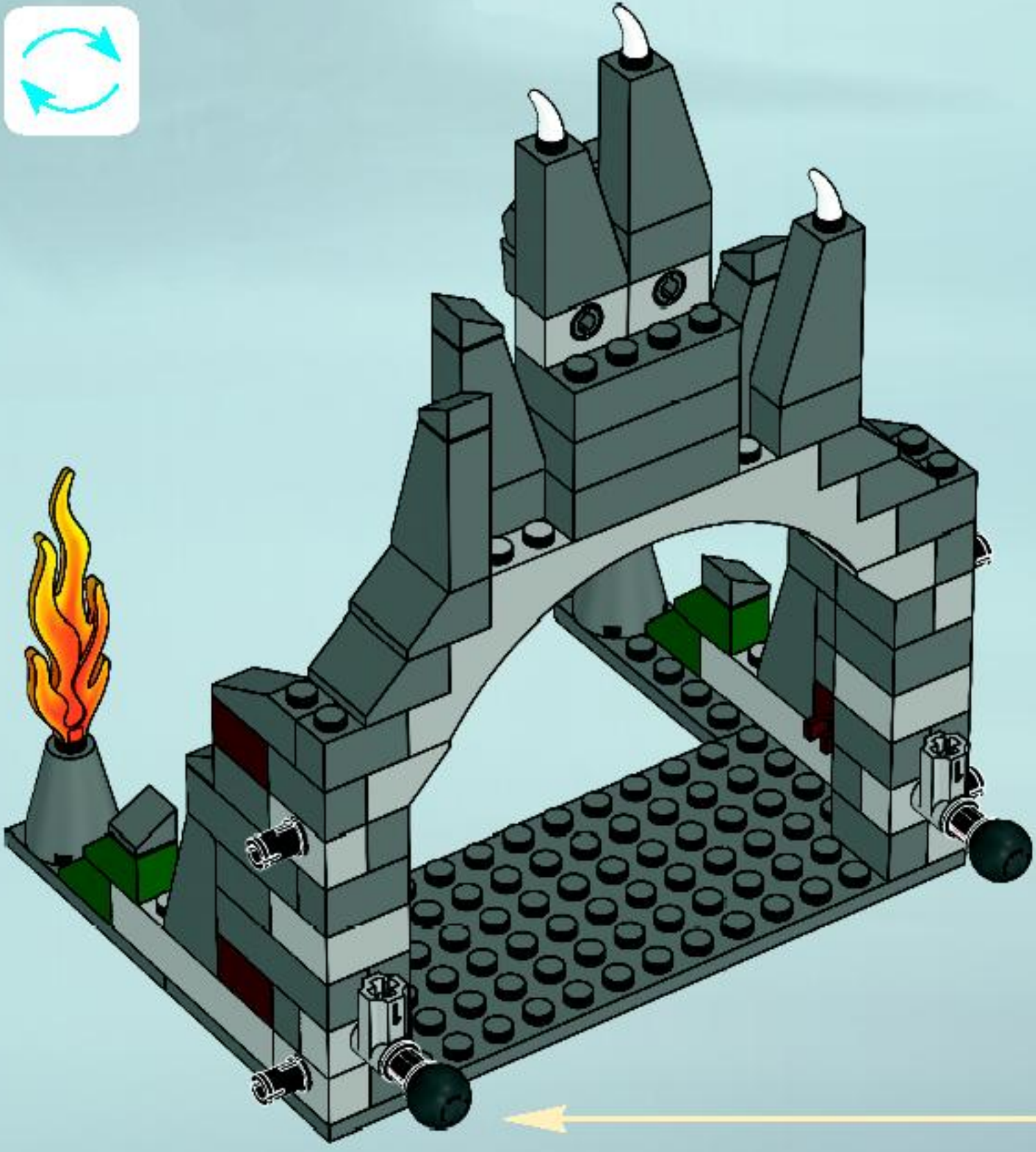
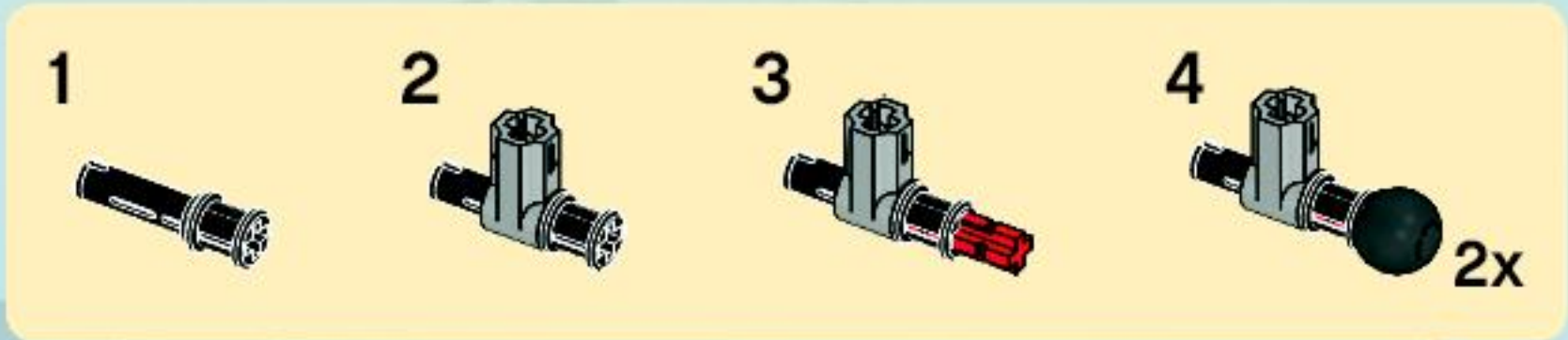



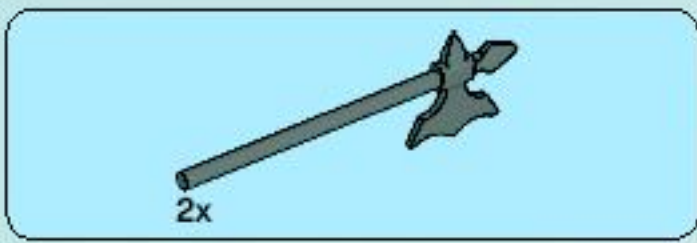

24

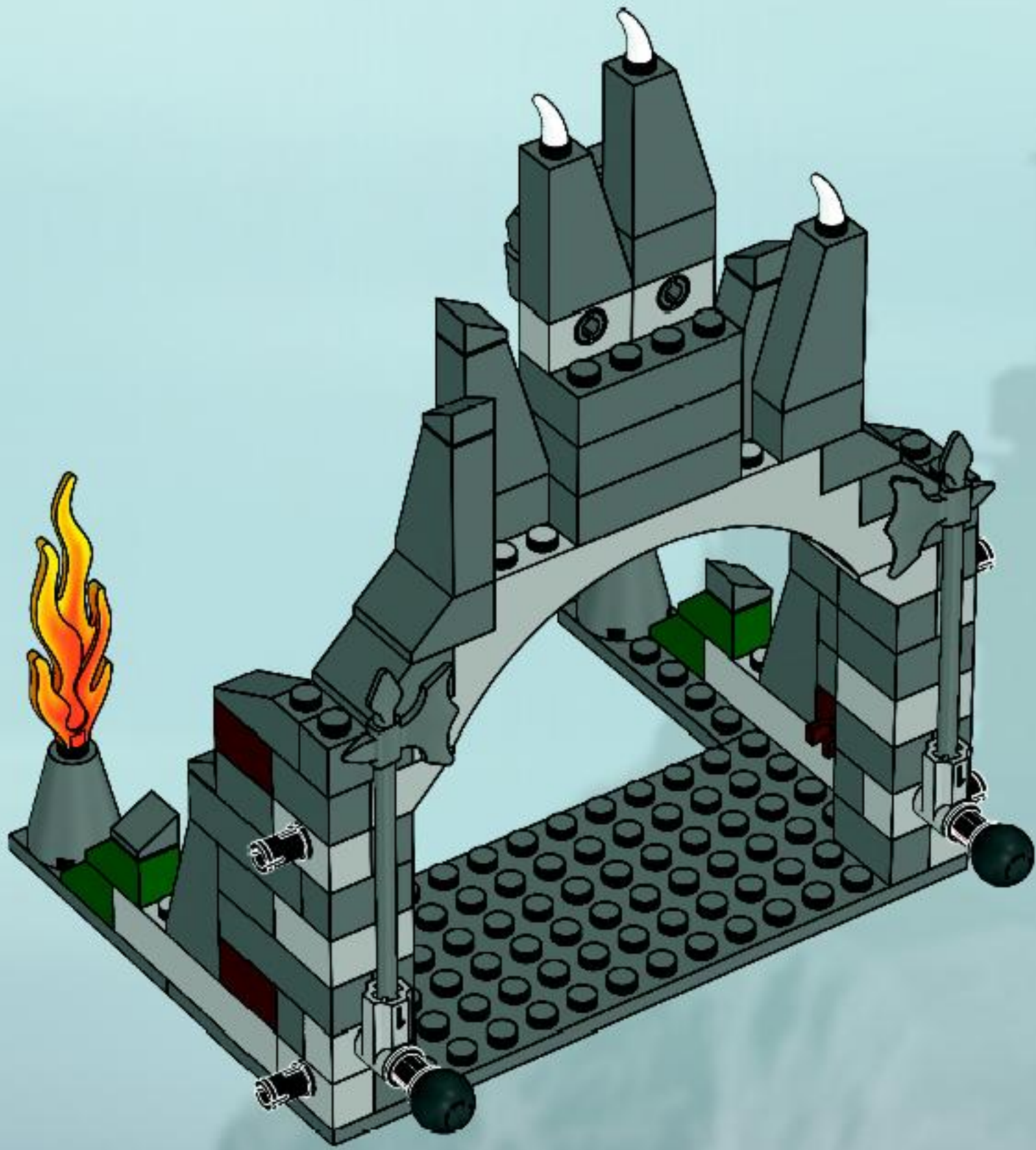



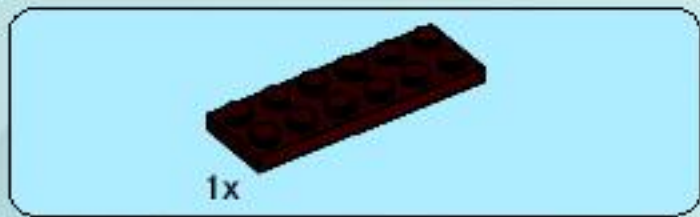

1

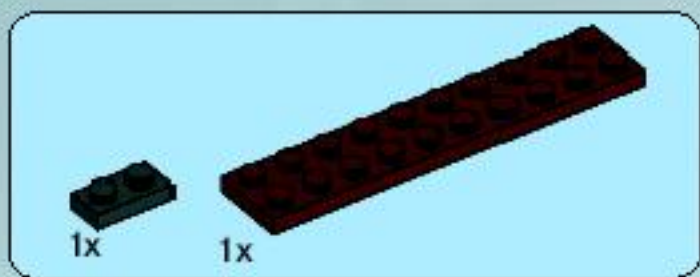

2

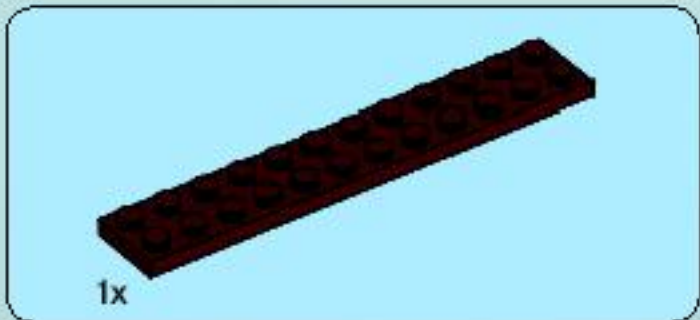
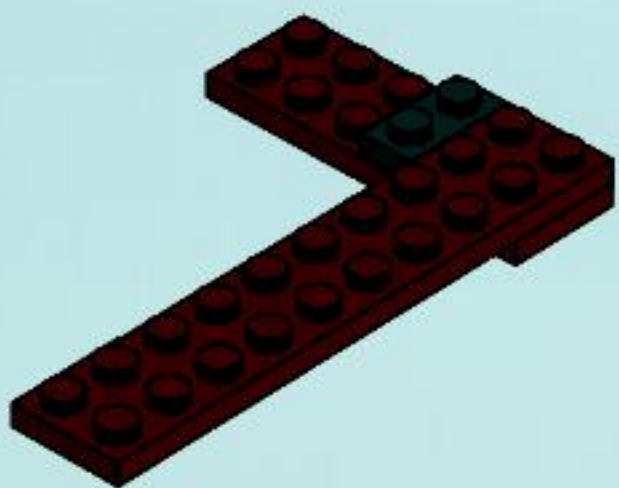

3

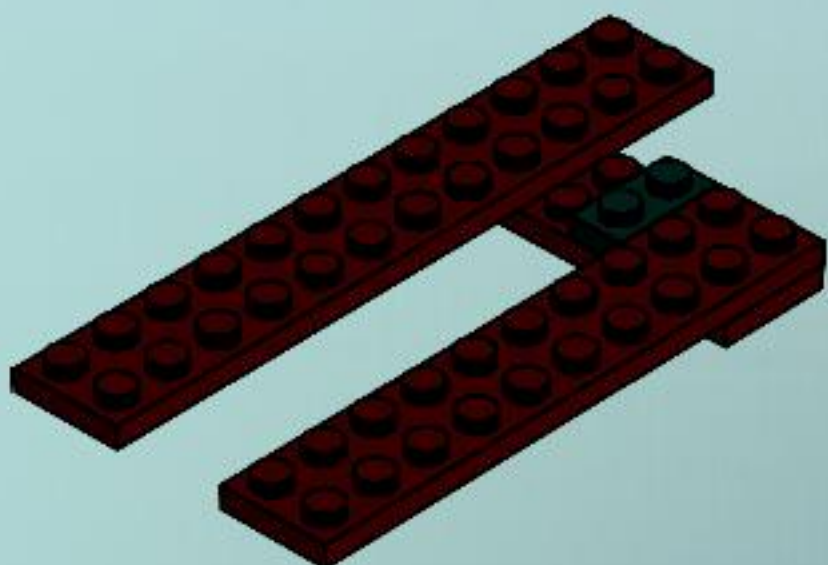

4

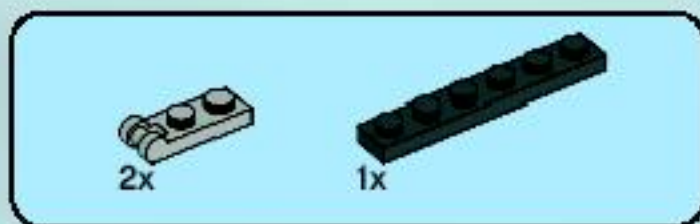
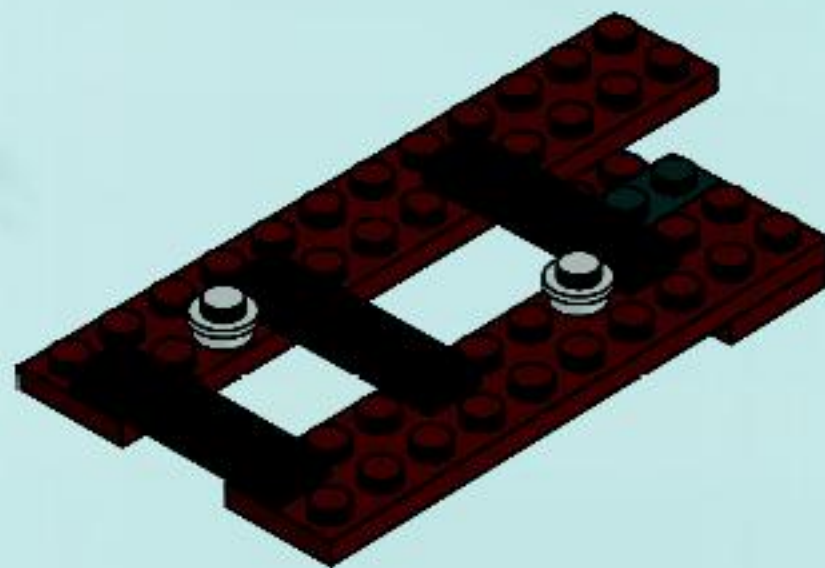

5

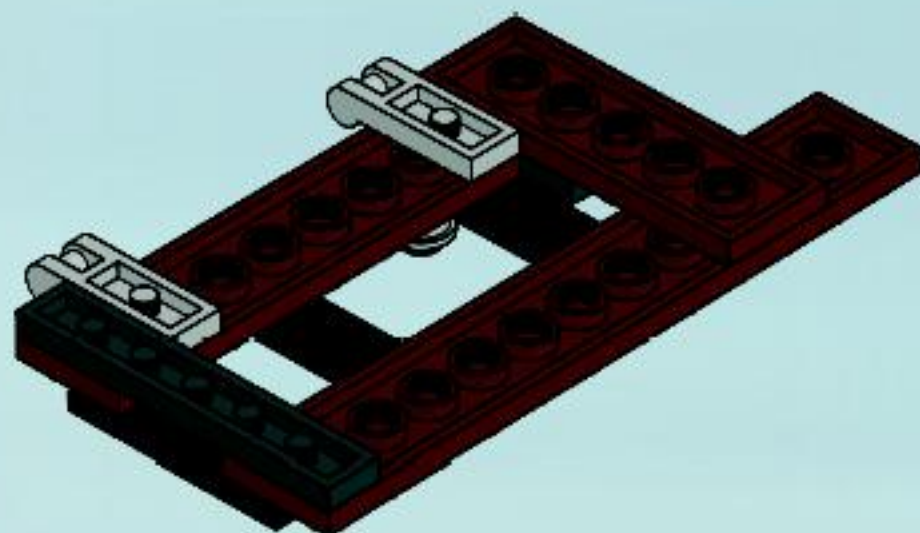

6

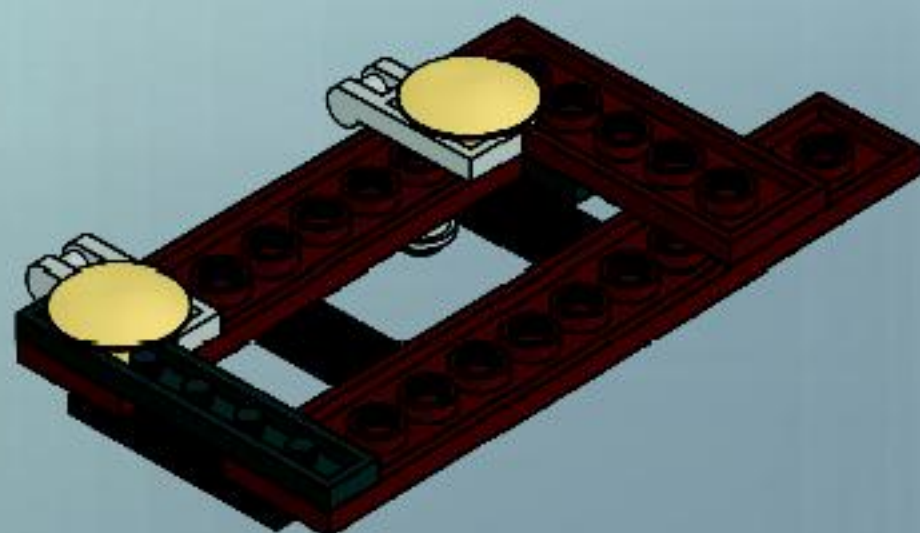



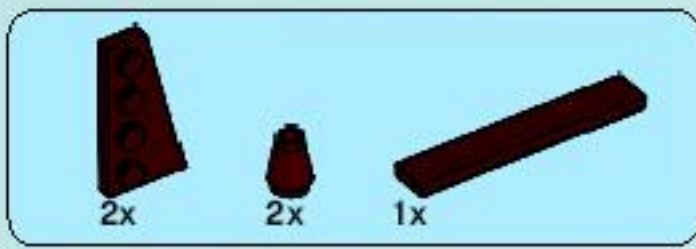

7

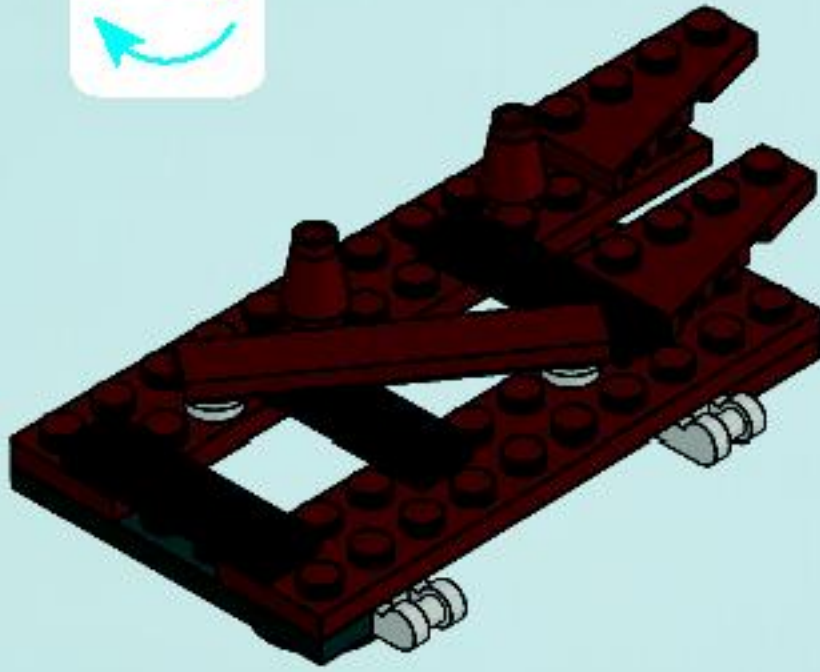

8

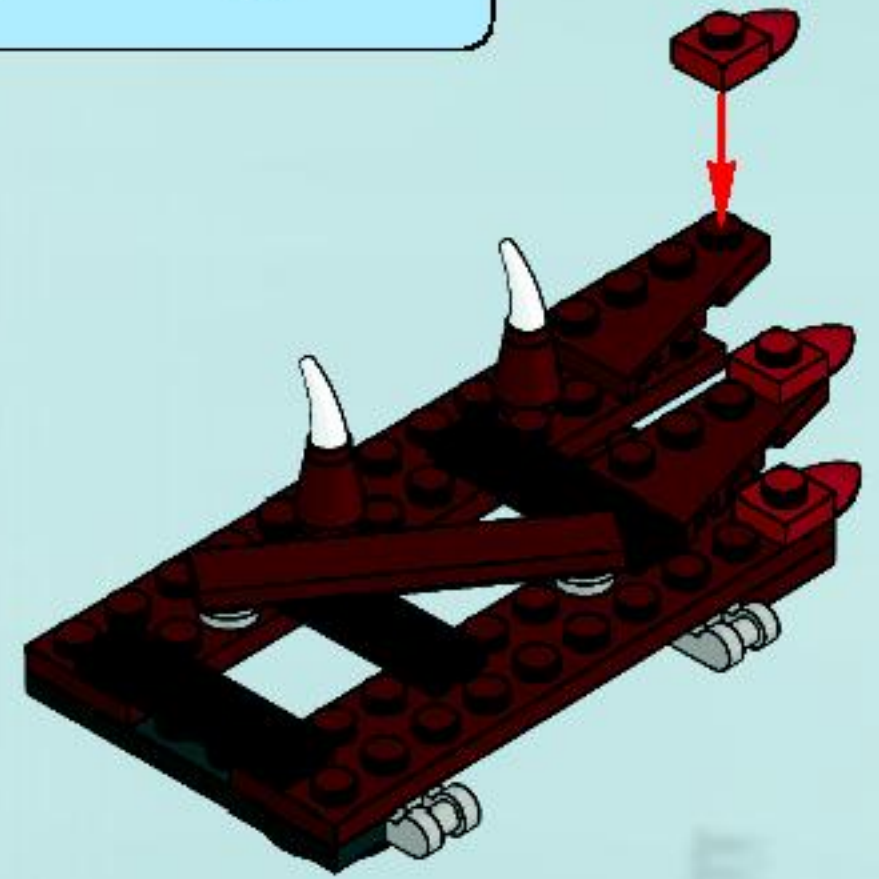

25

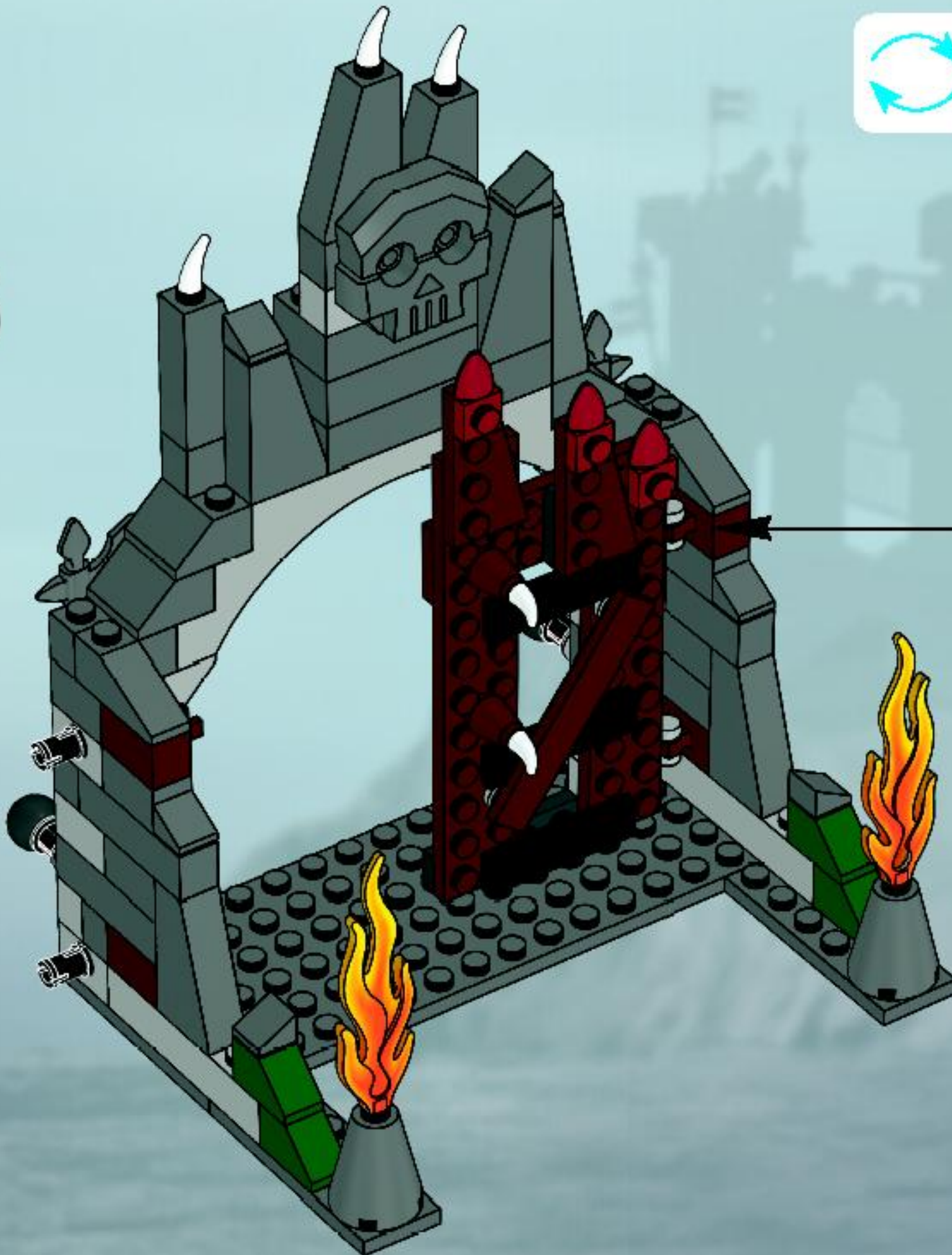



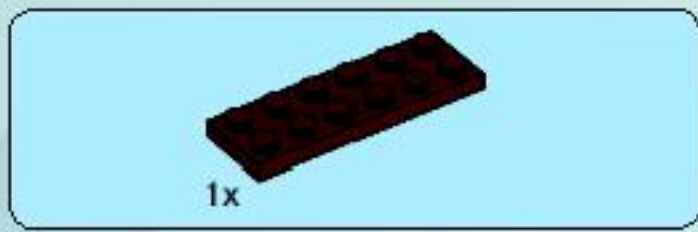

1

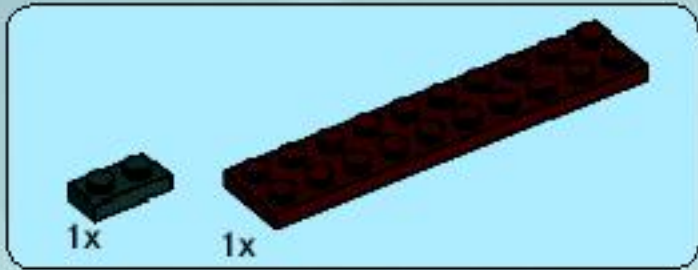

2

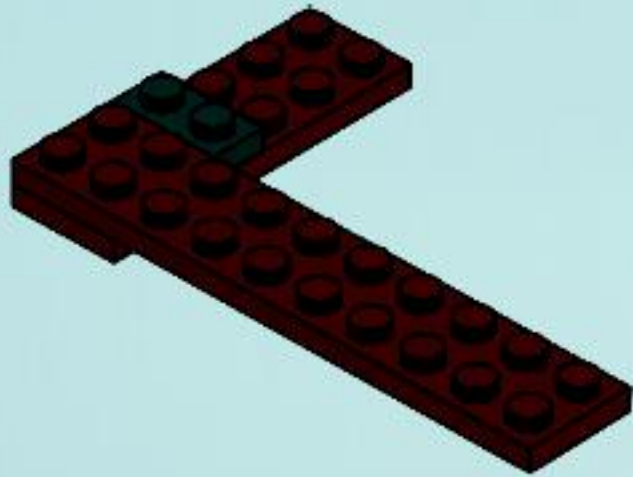

3

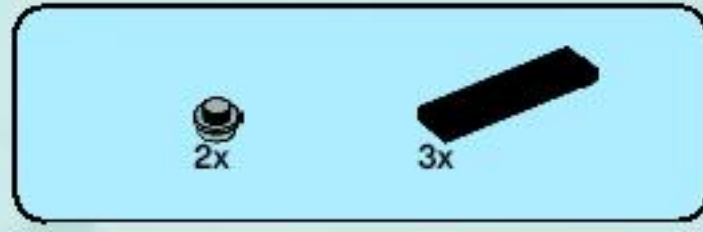
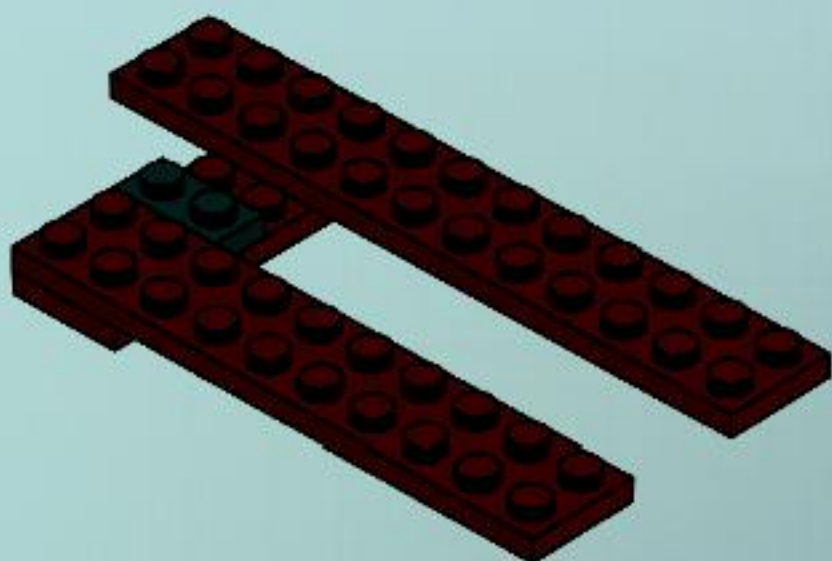

4

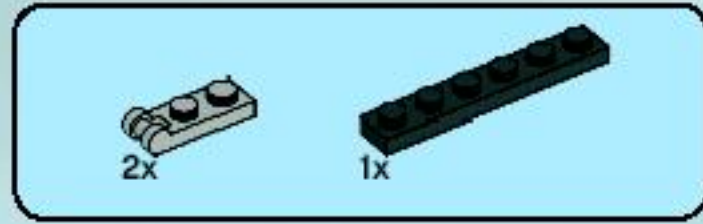
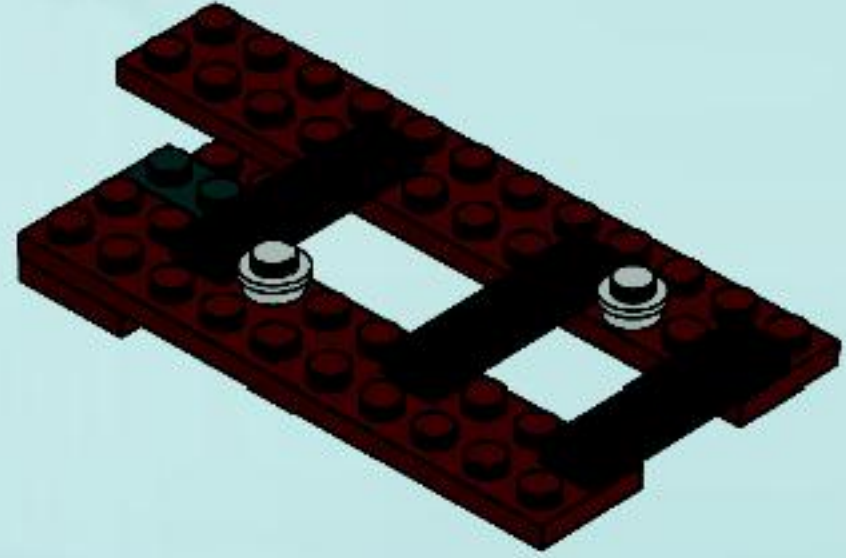

5

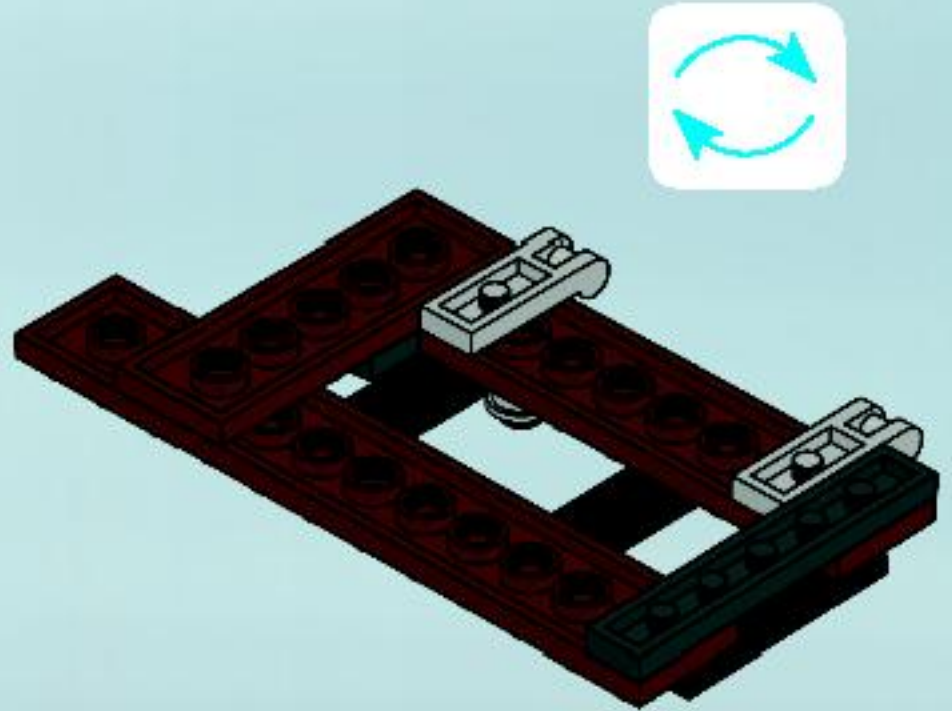

6

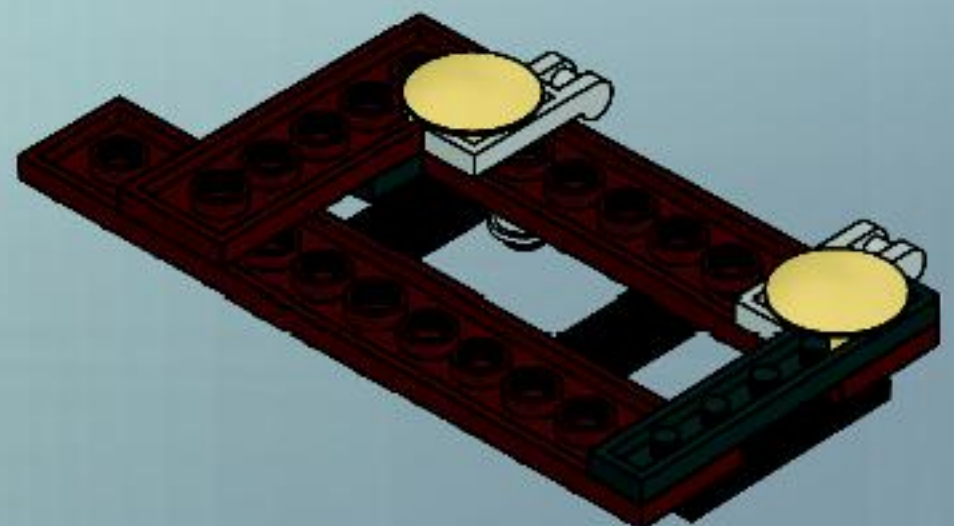



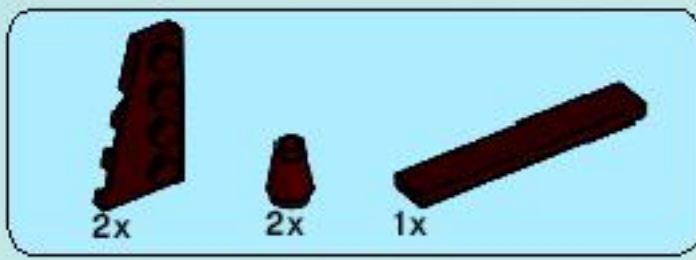

7

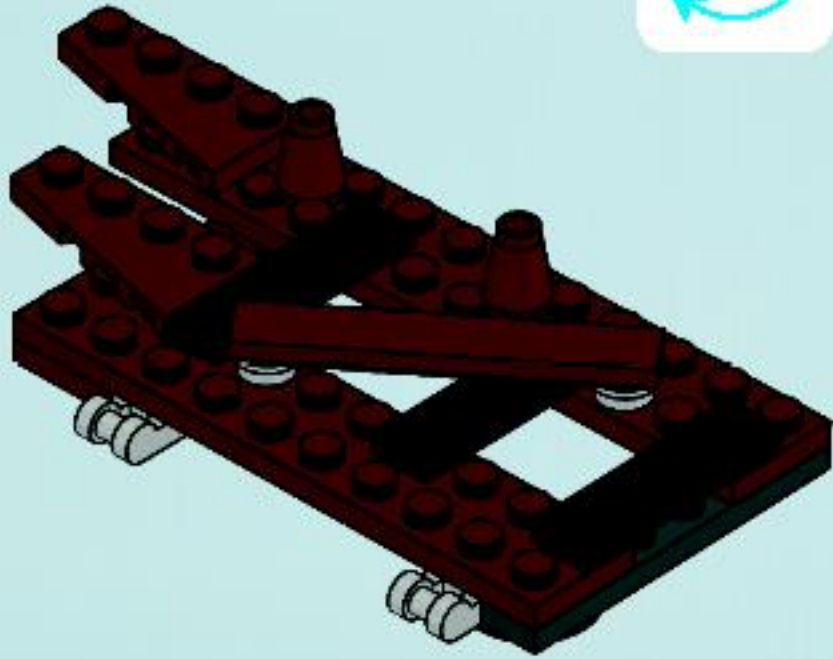

8

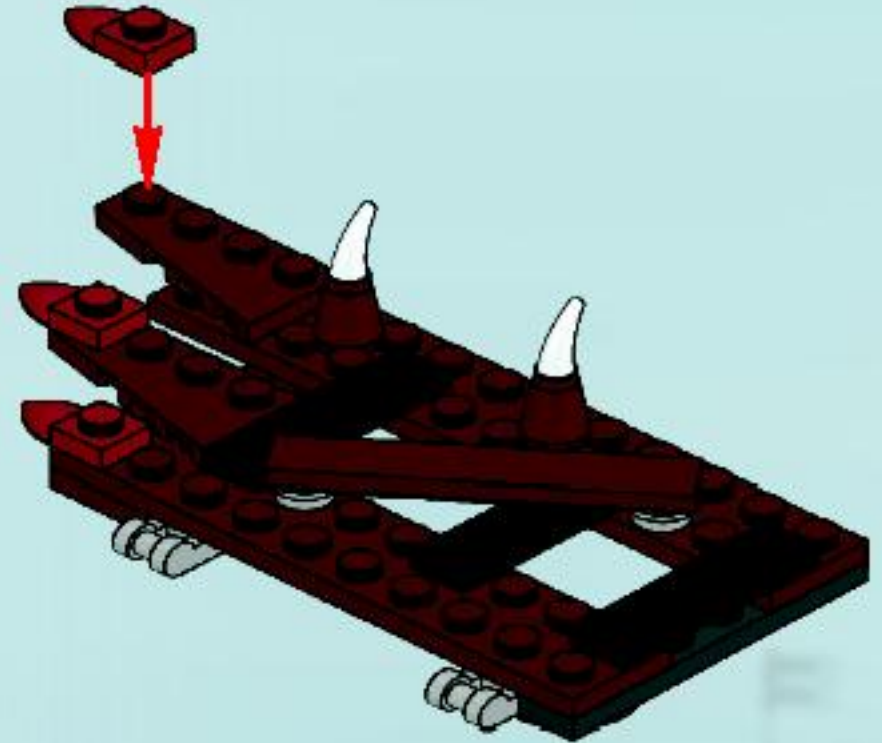

26

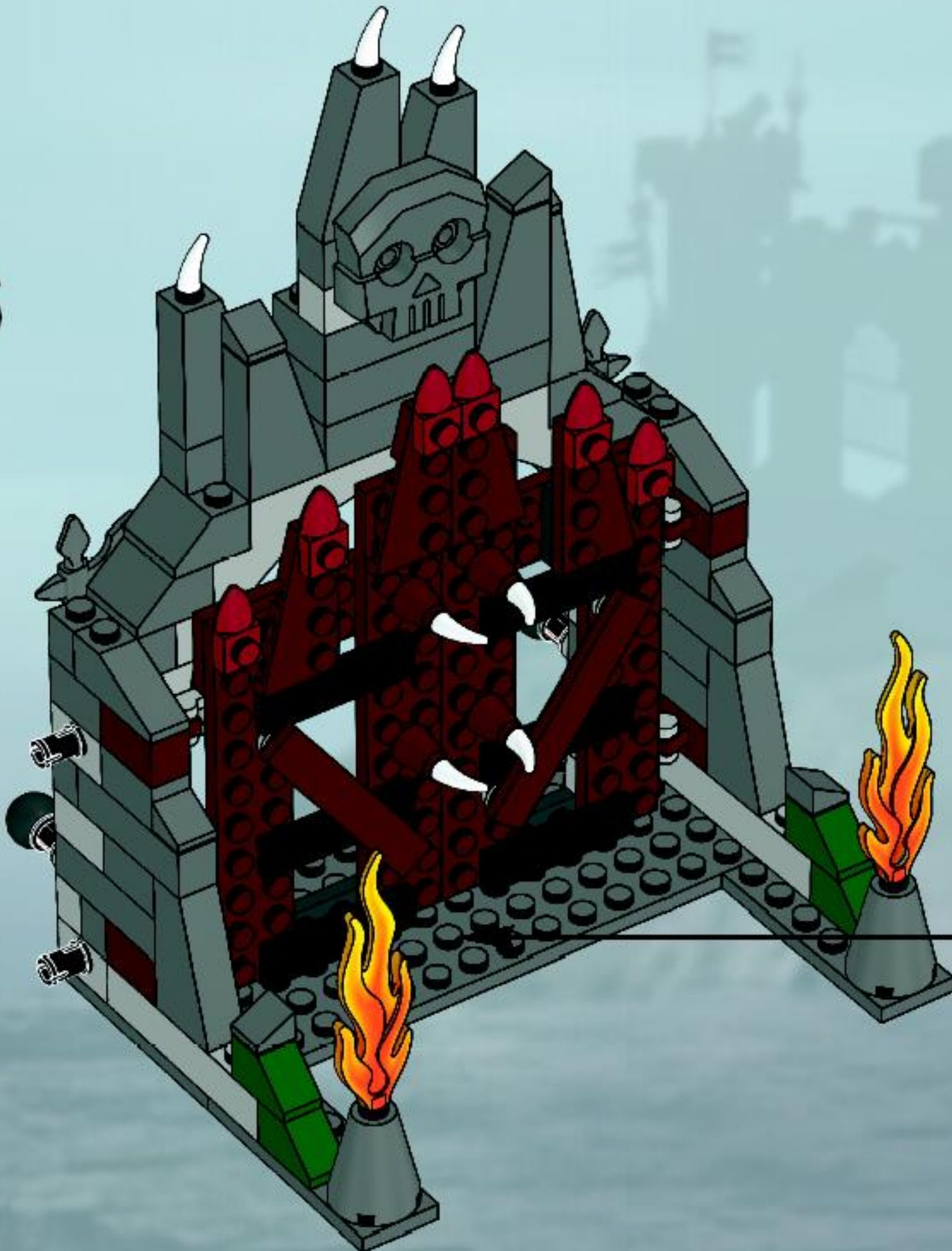





3

+



4

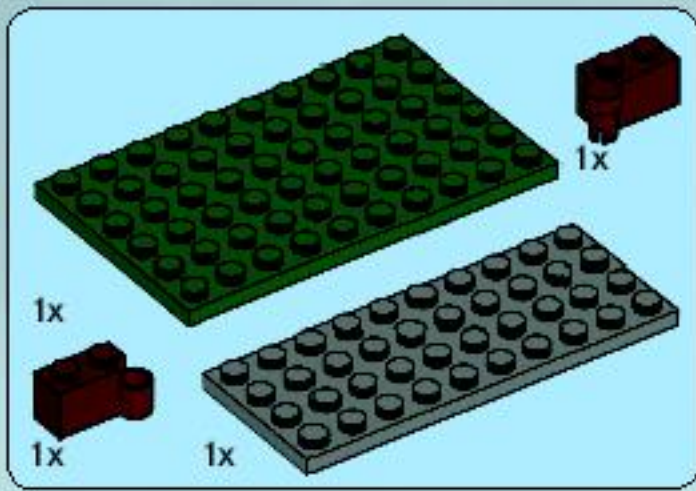
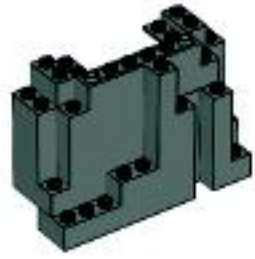

1

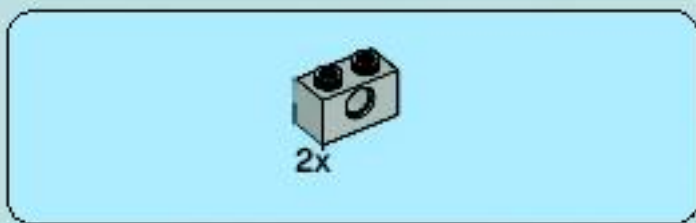
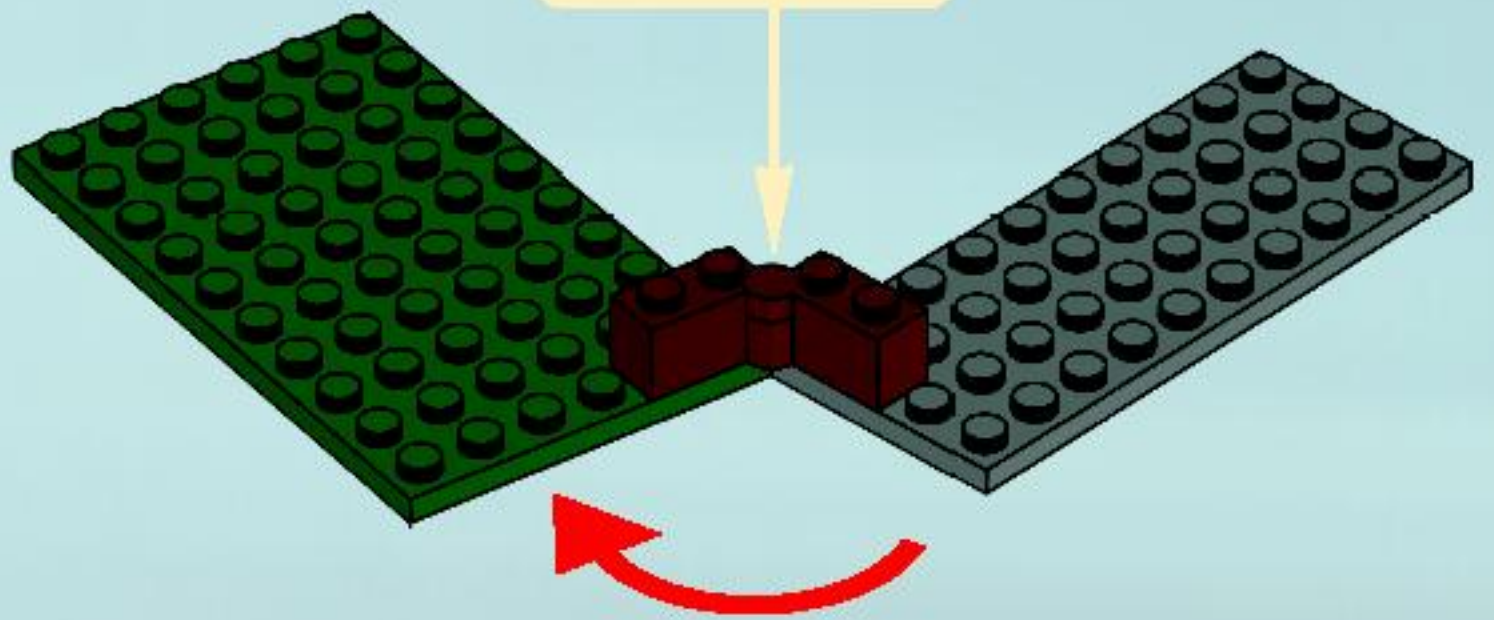
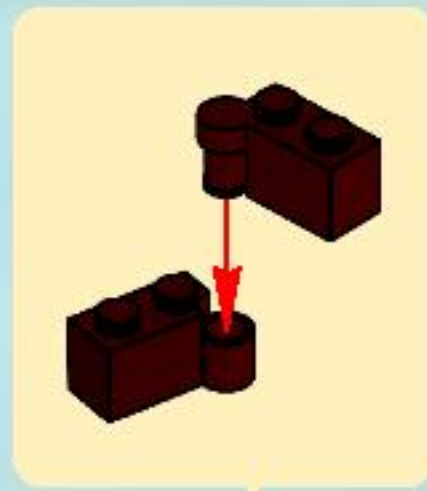

2

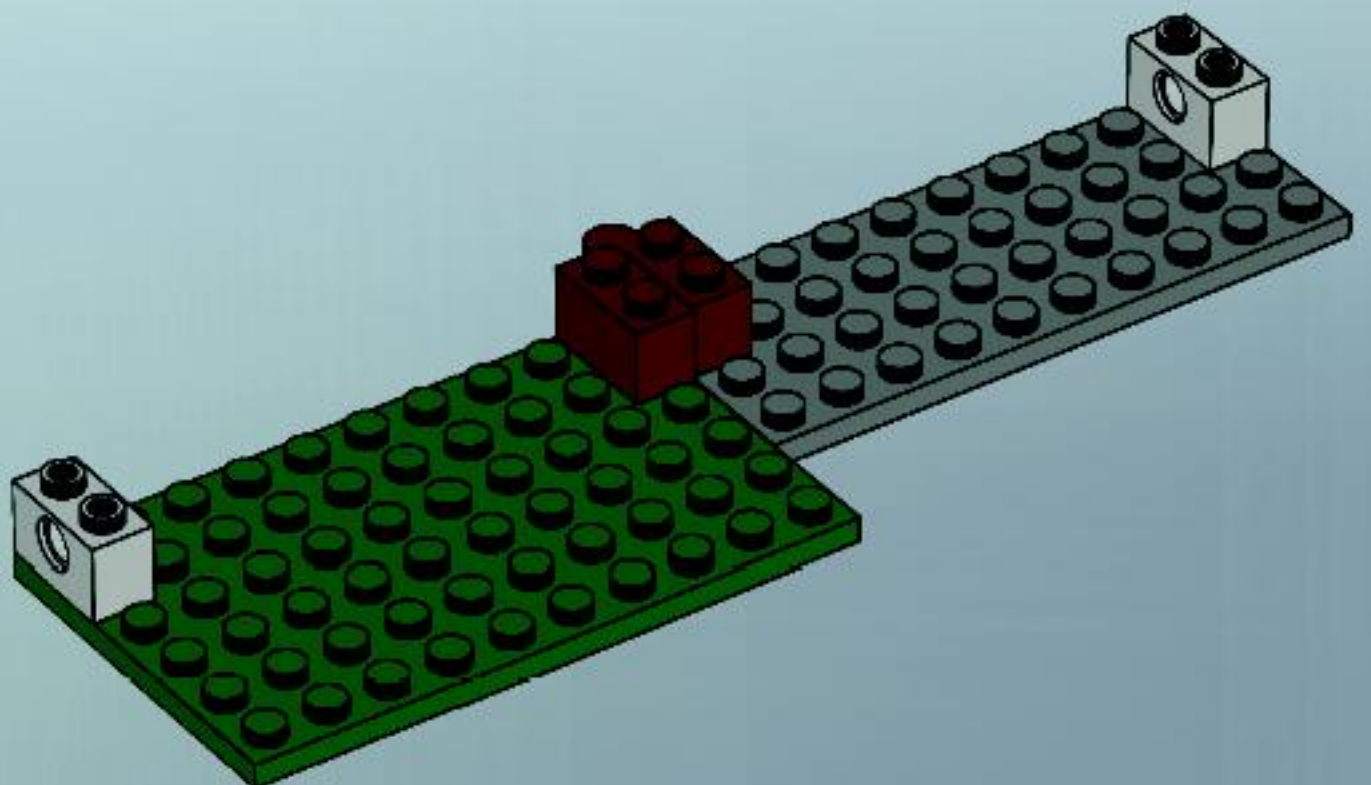



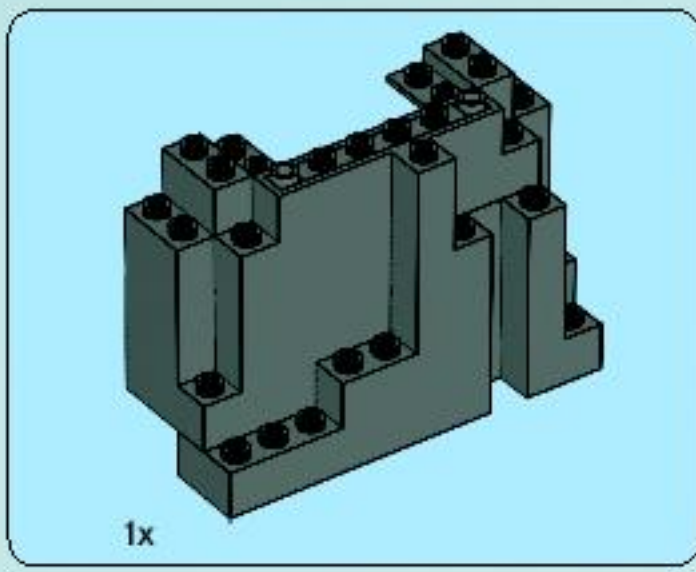

3

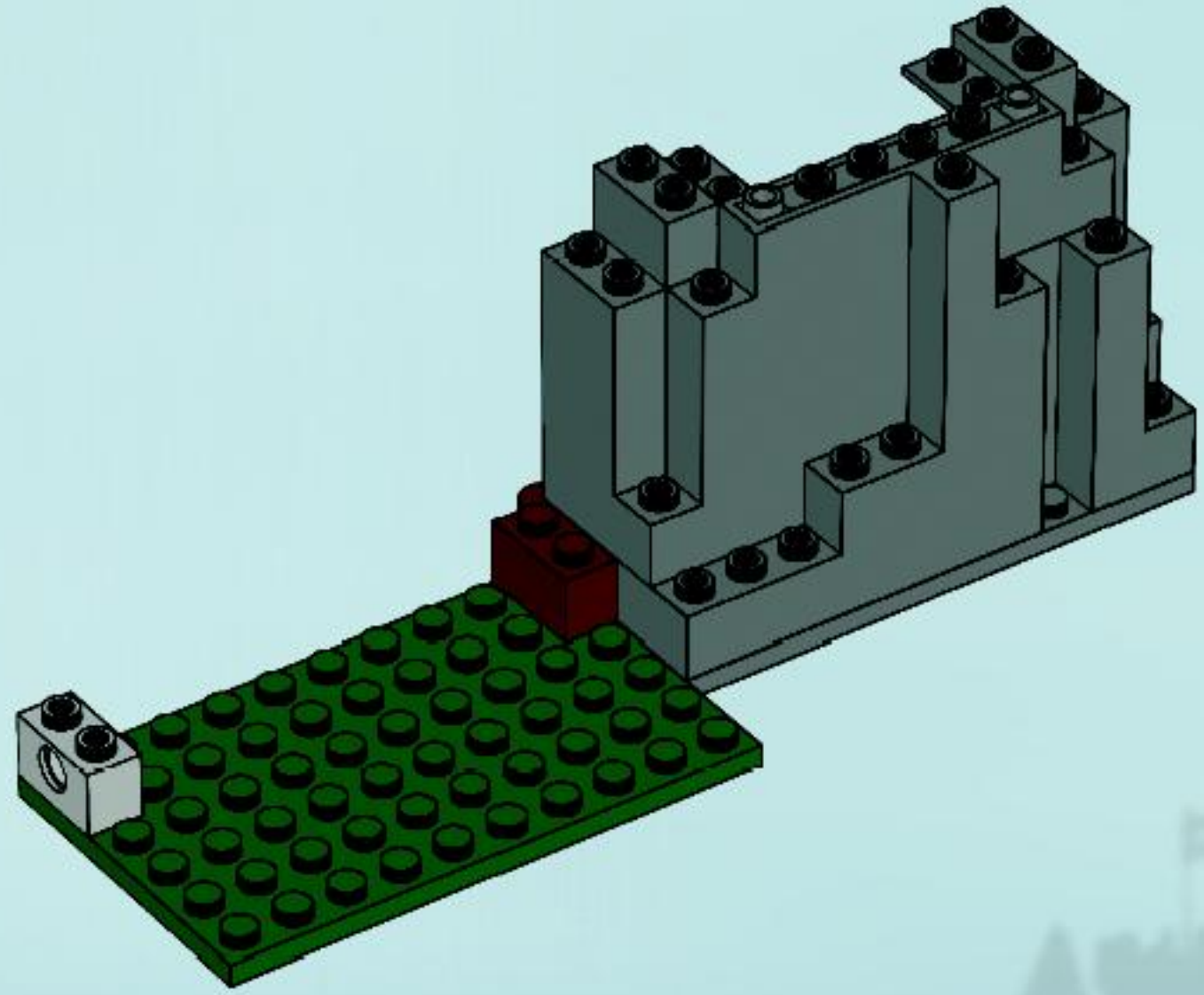

4

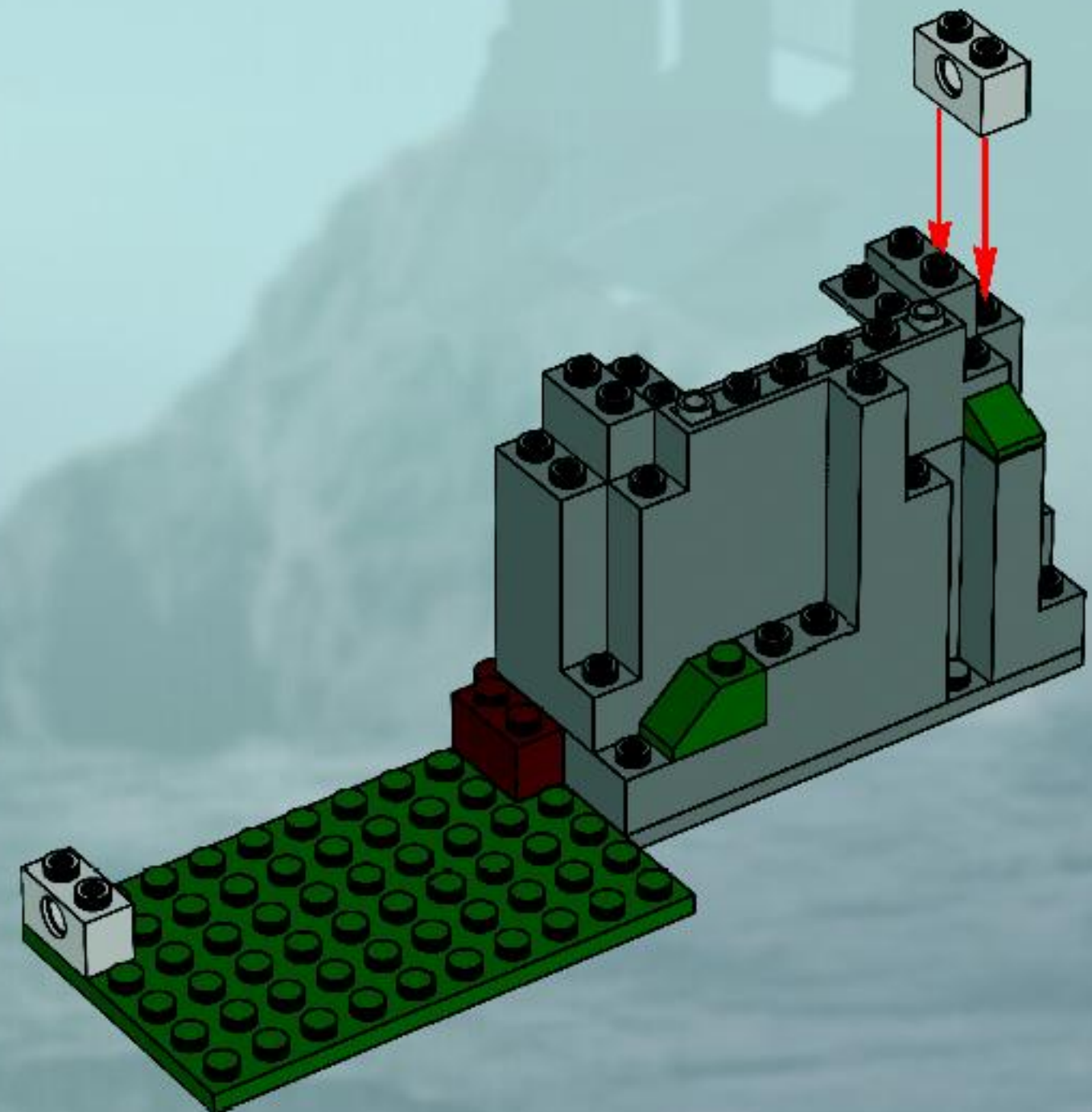



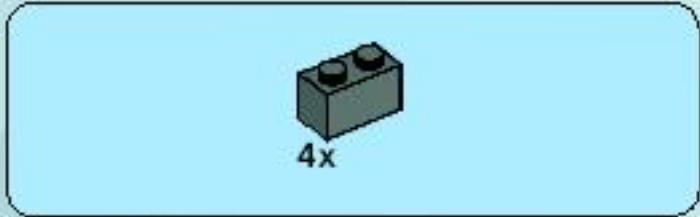

5

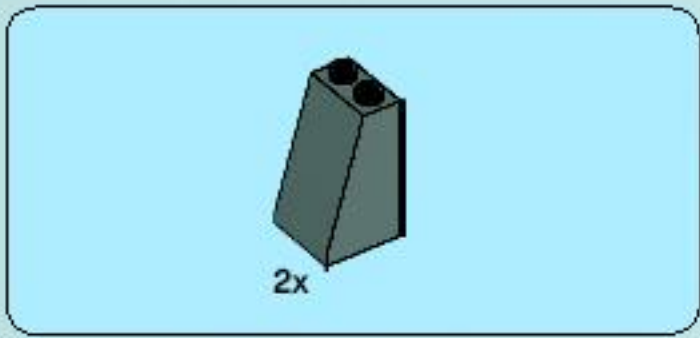
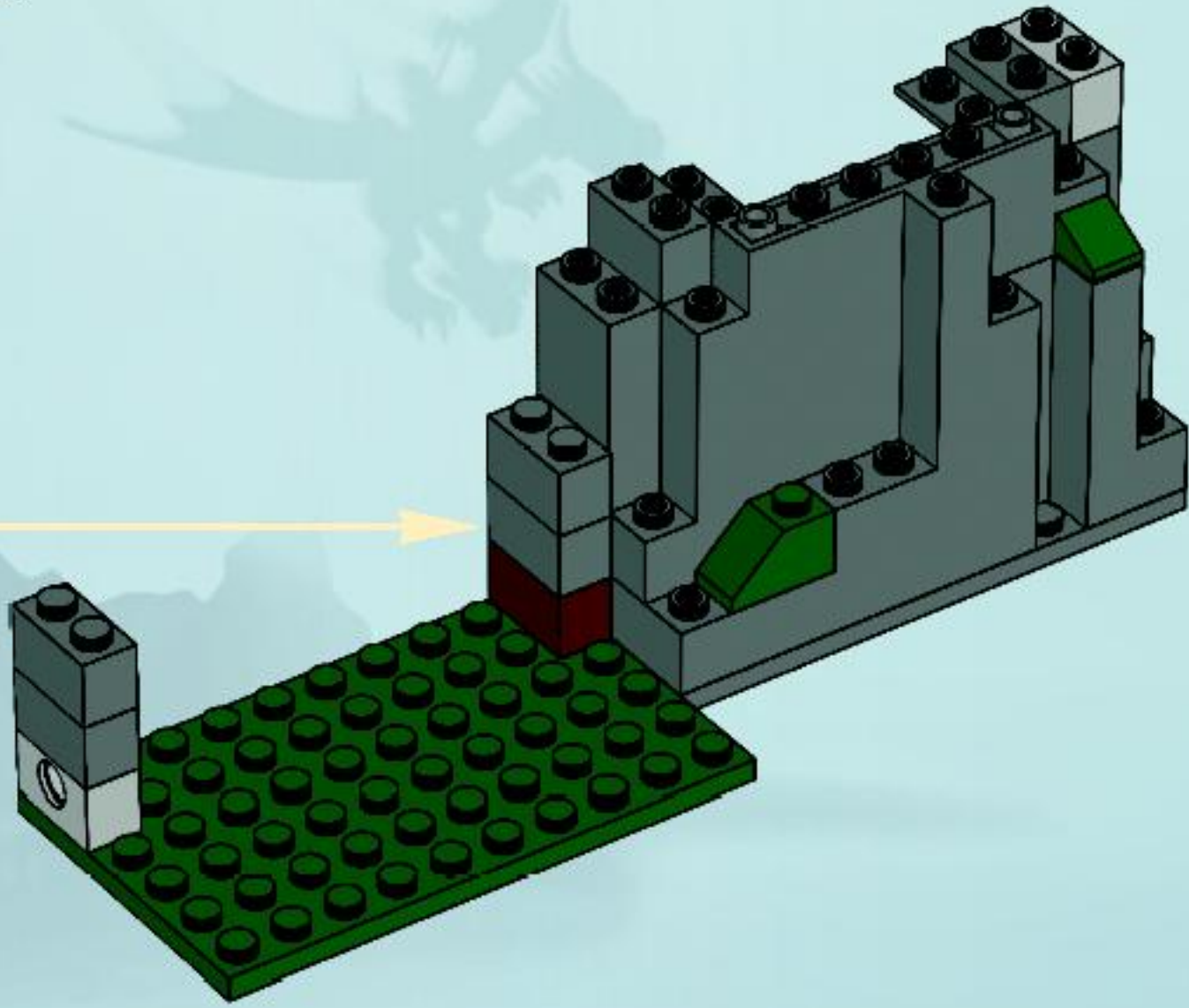
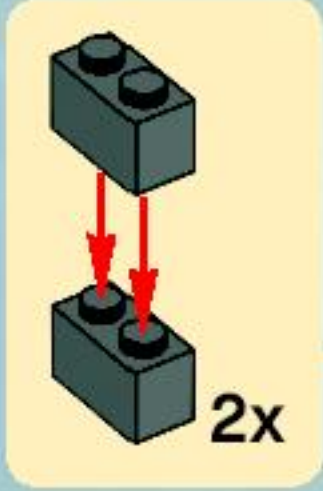

6

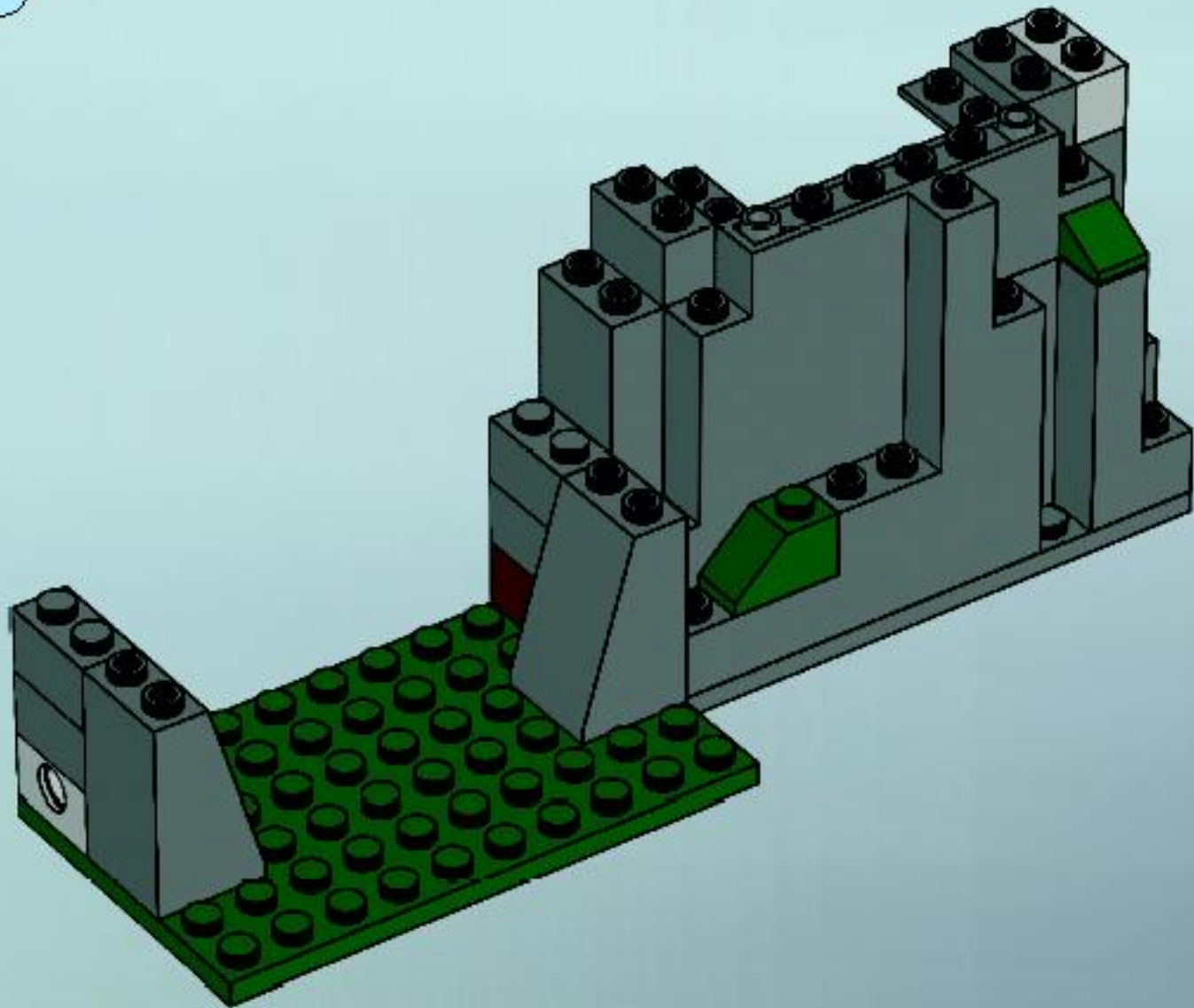



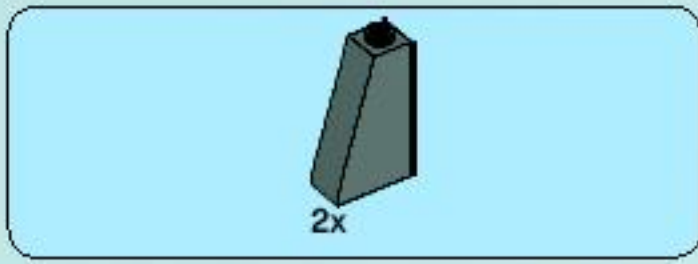

7

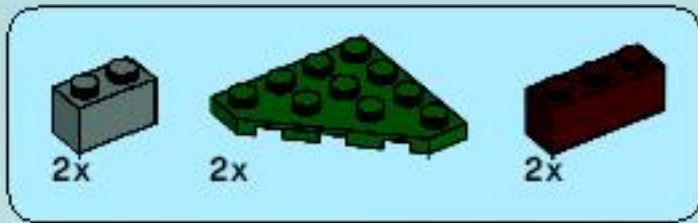
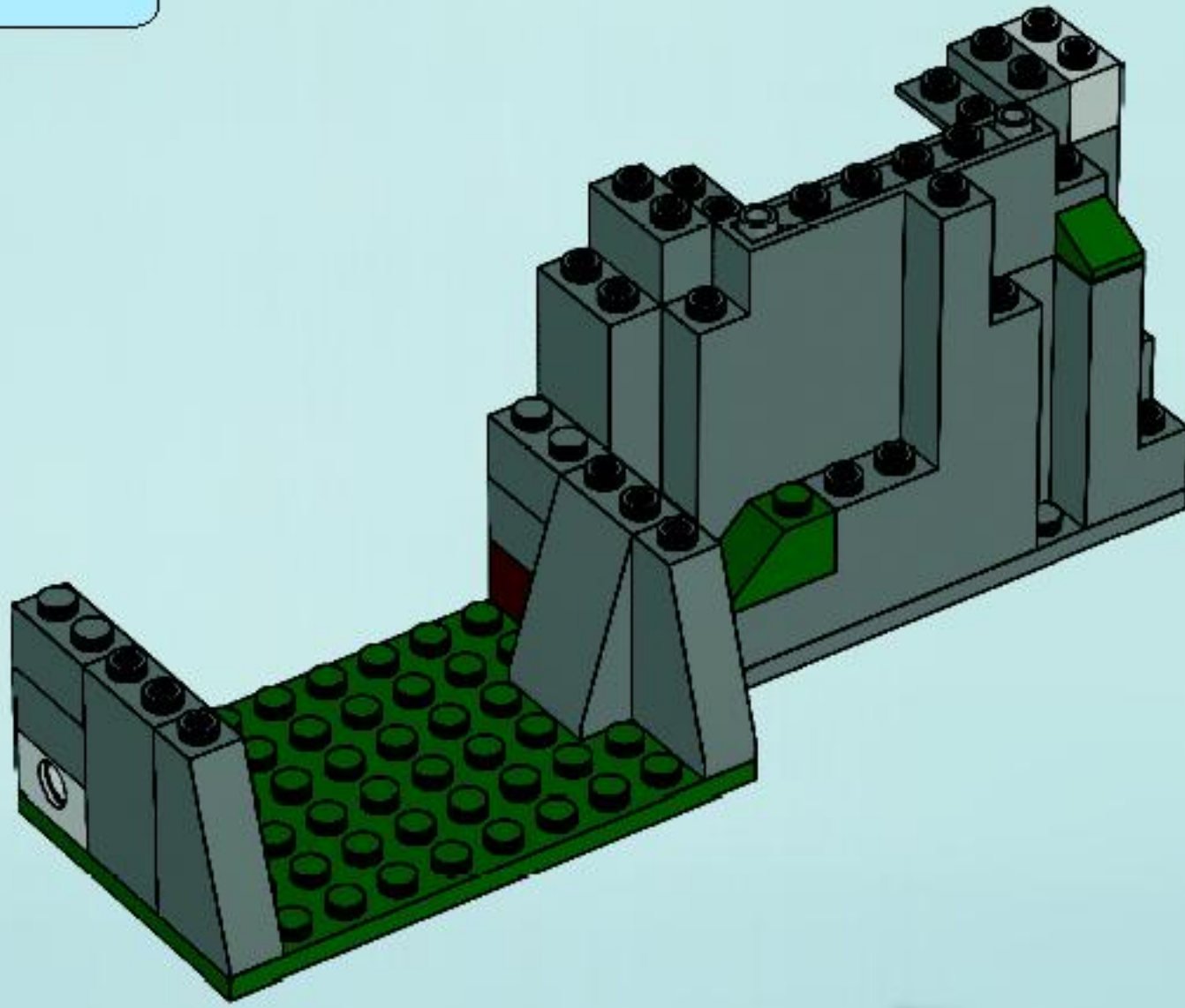

8

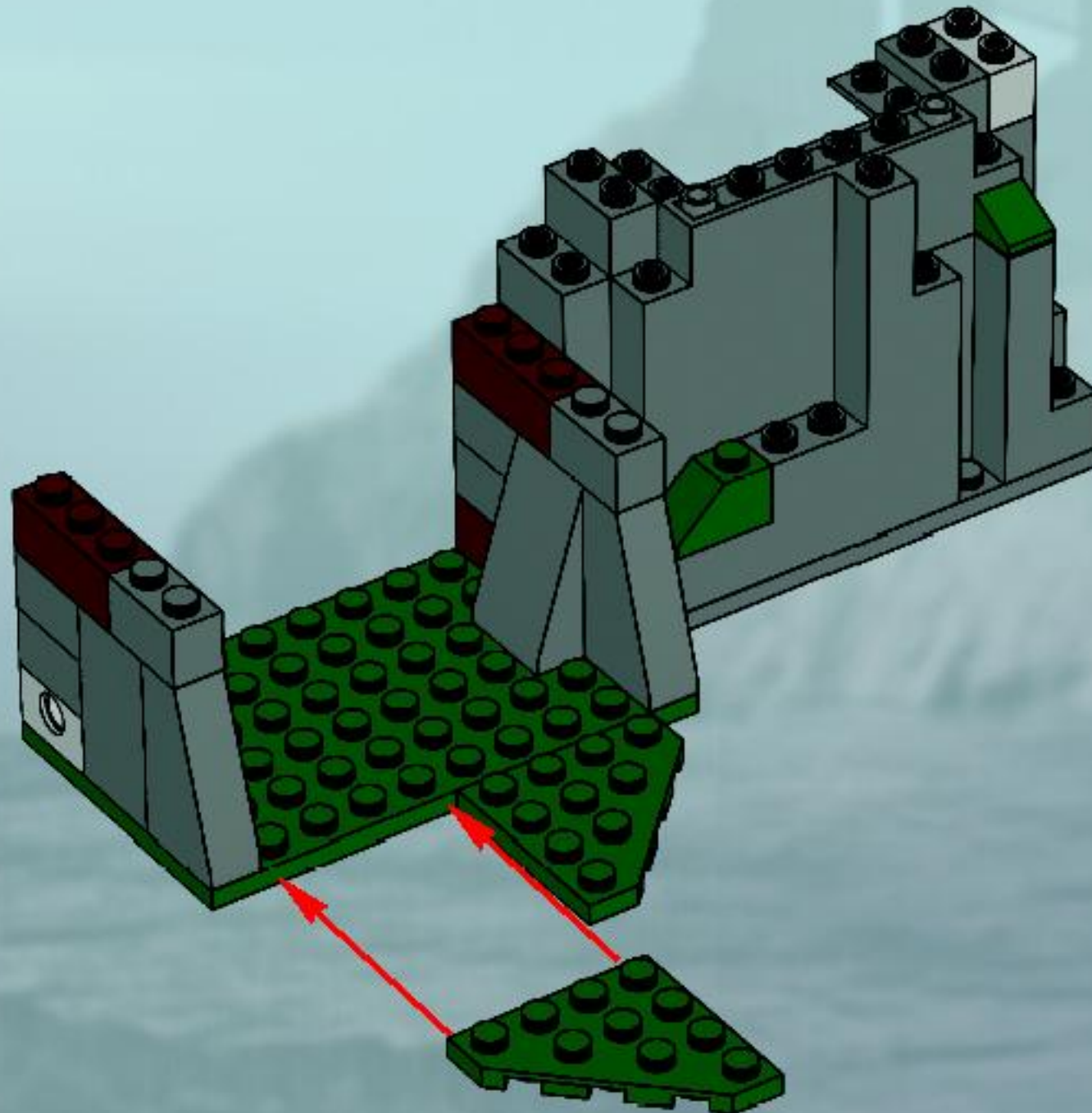





9

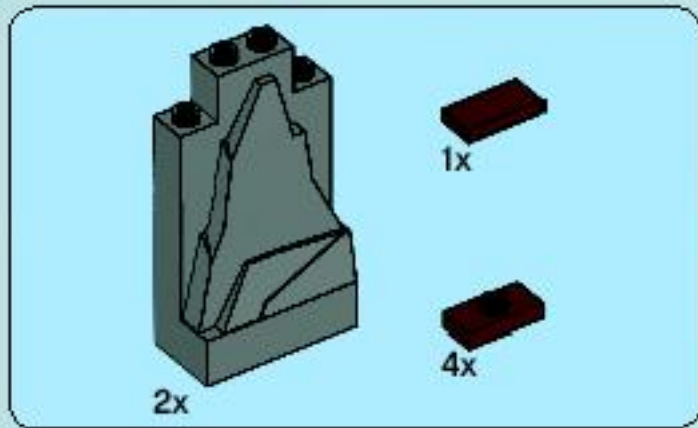
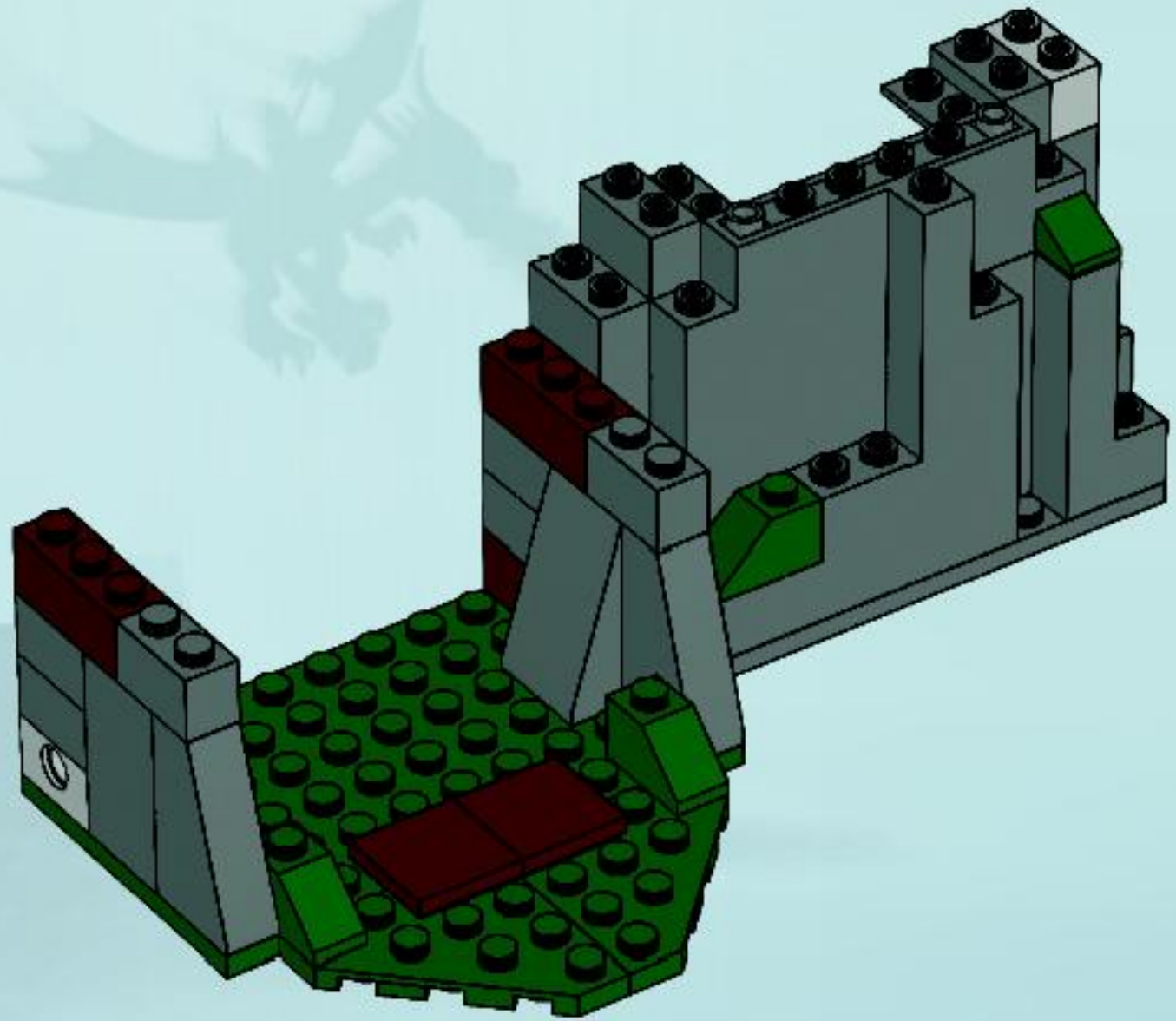

10

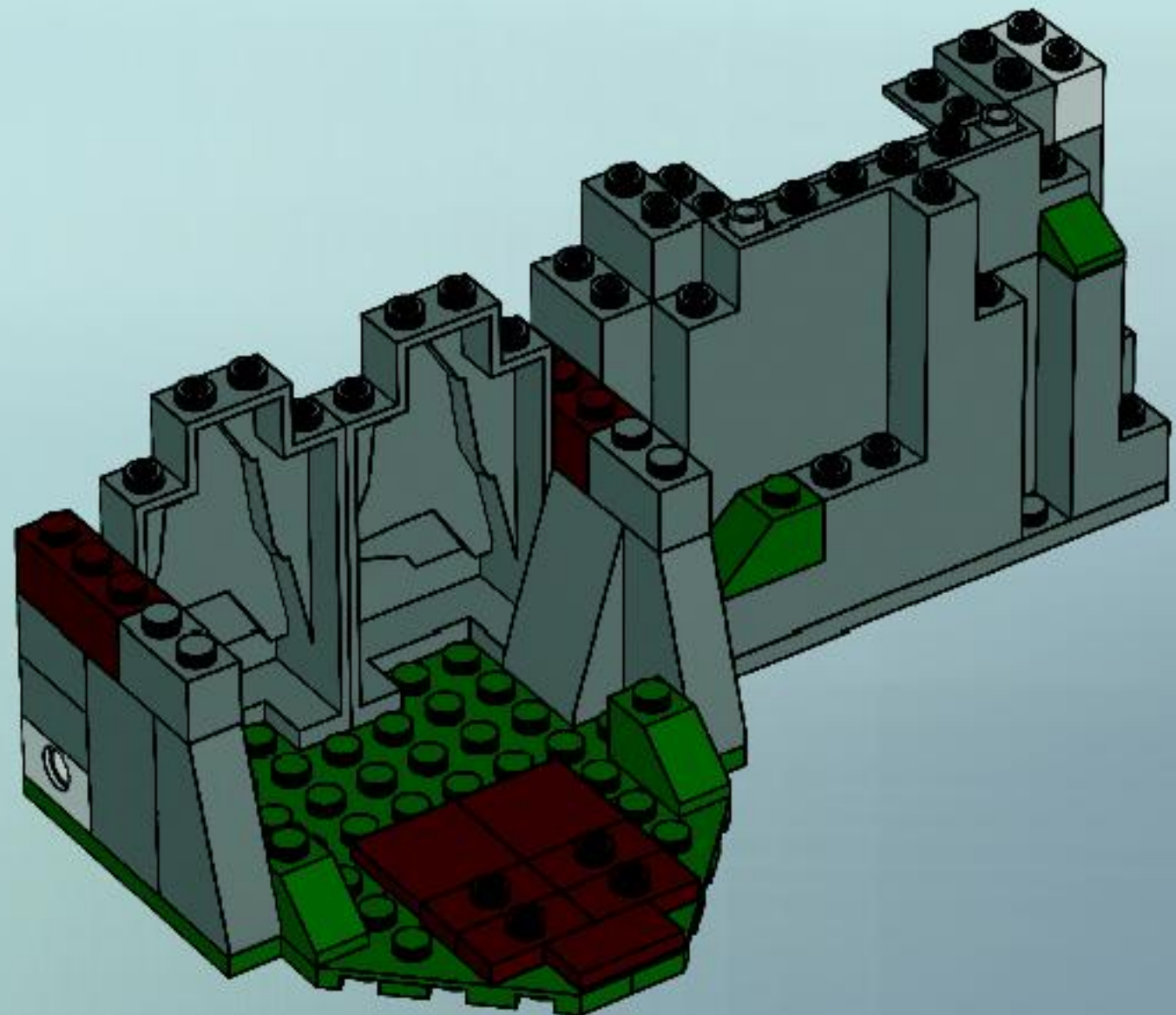



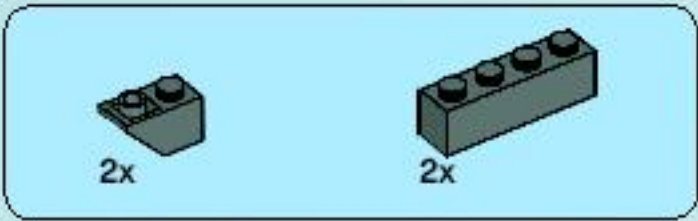

11

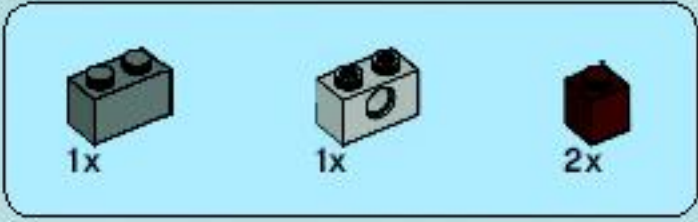
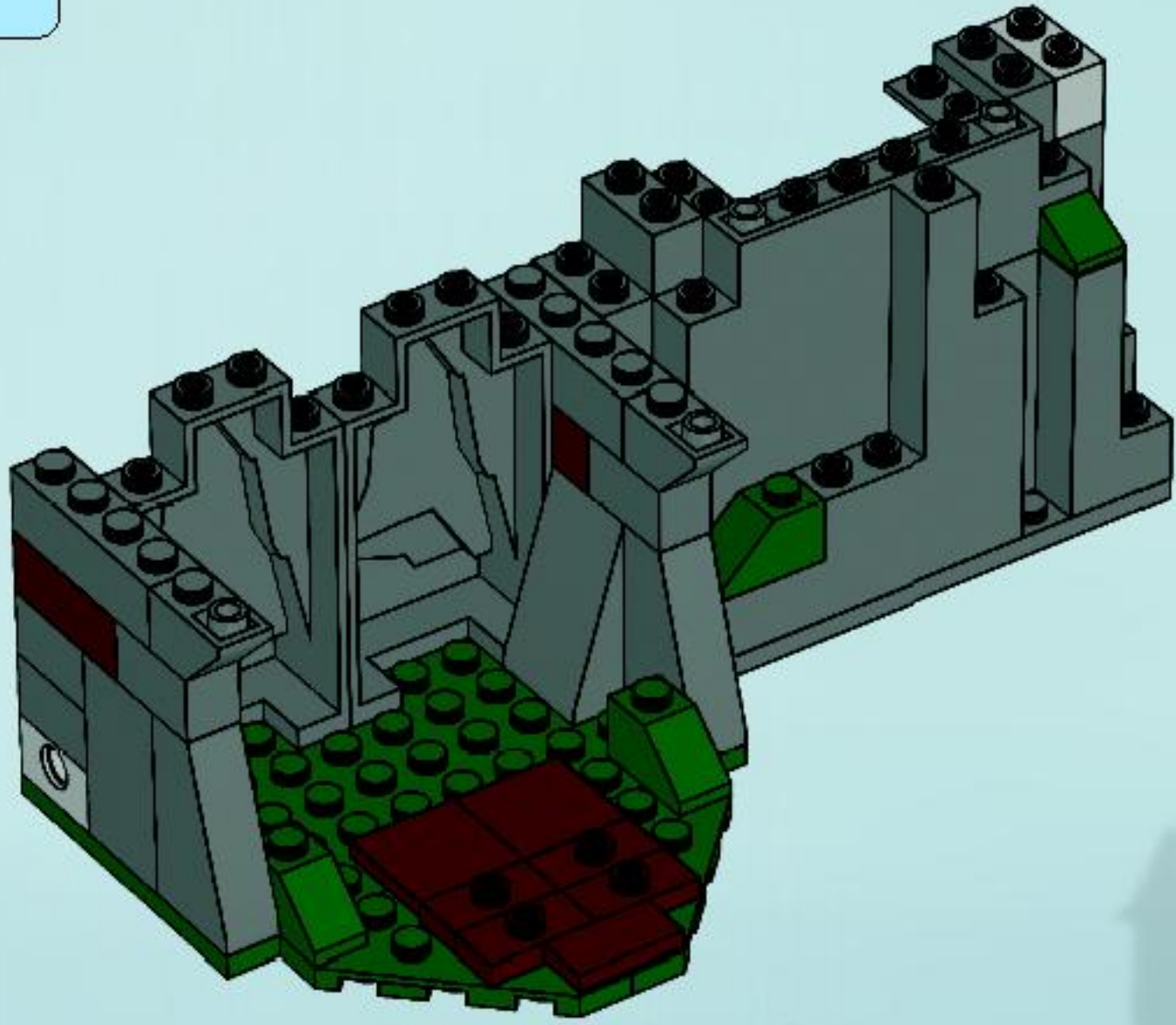

12

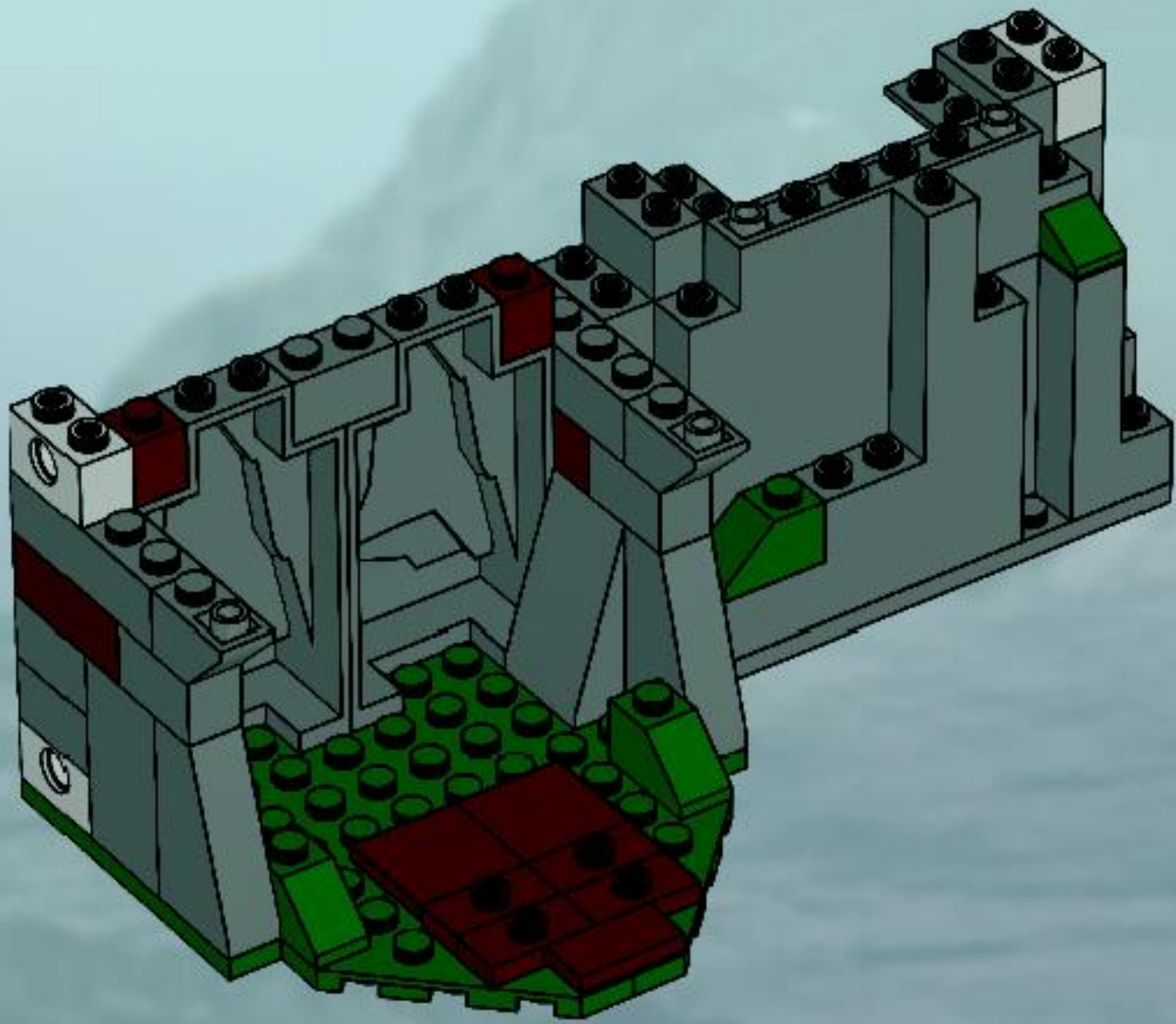



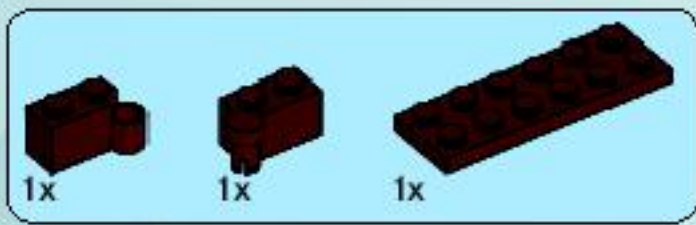

13

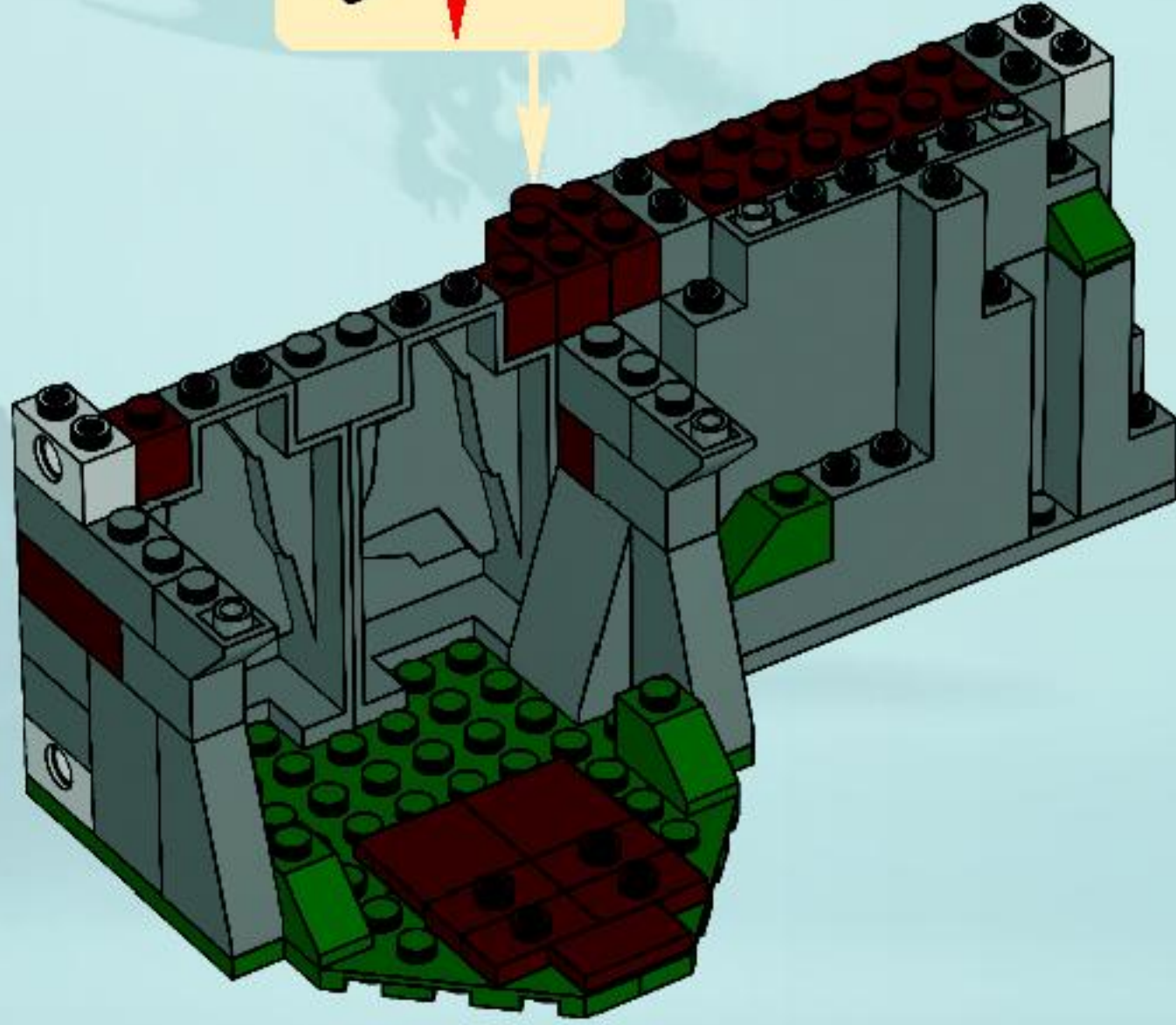
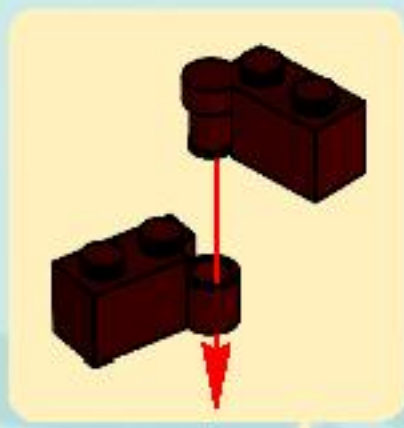

14

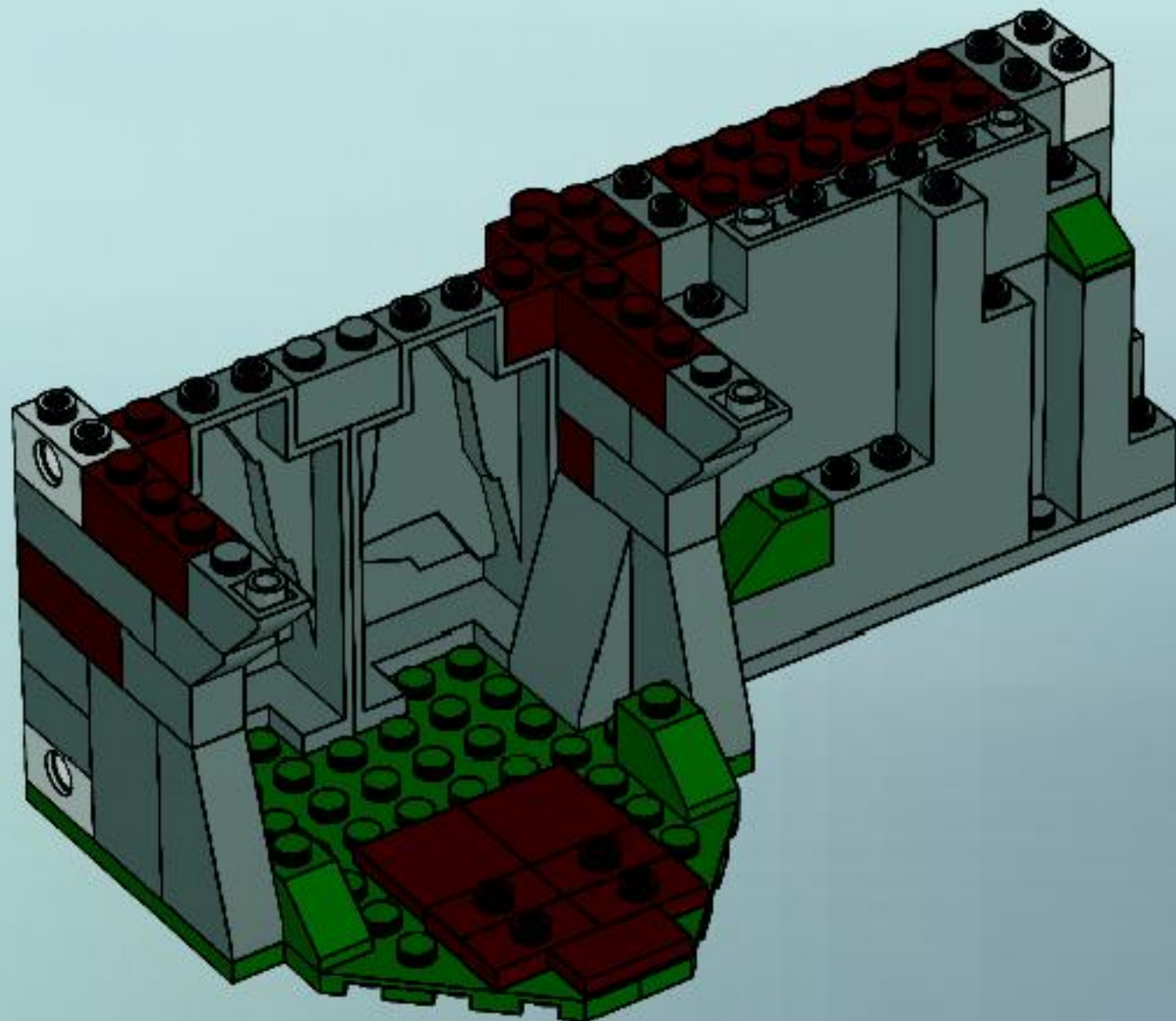



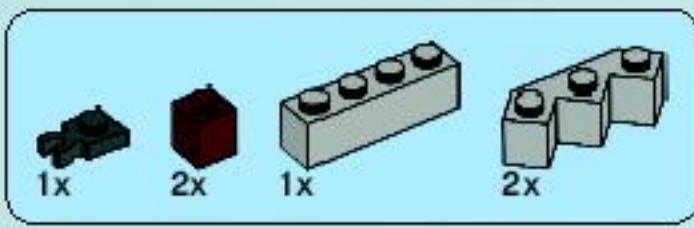

15

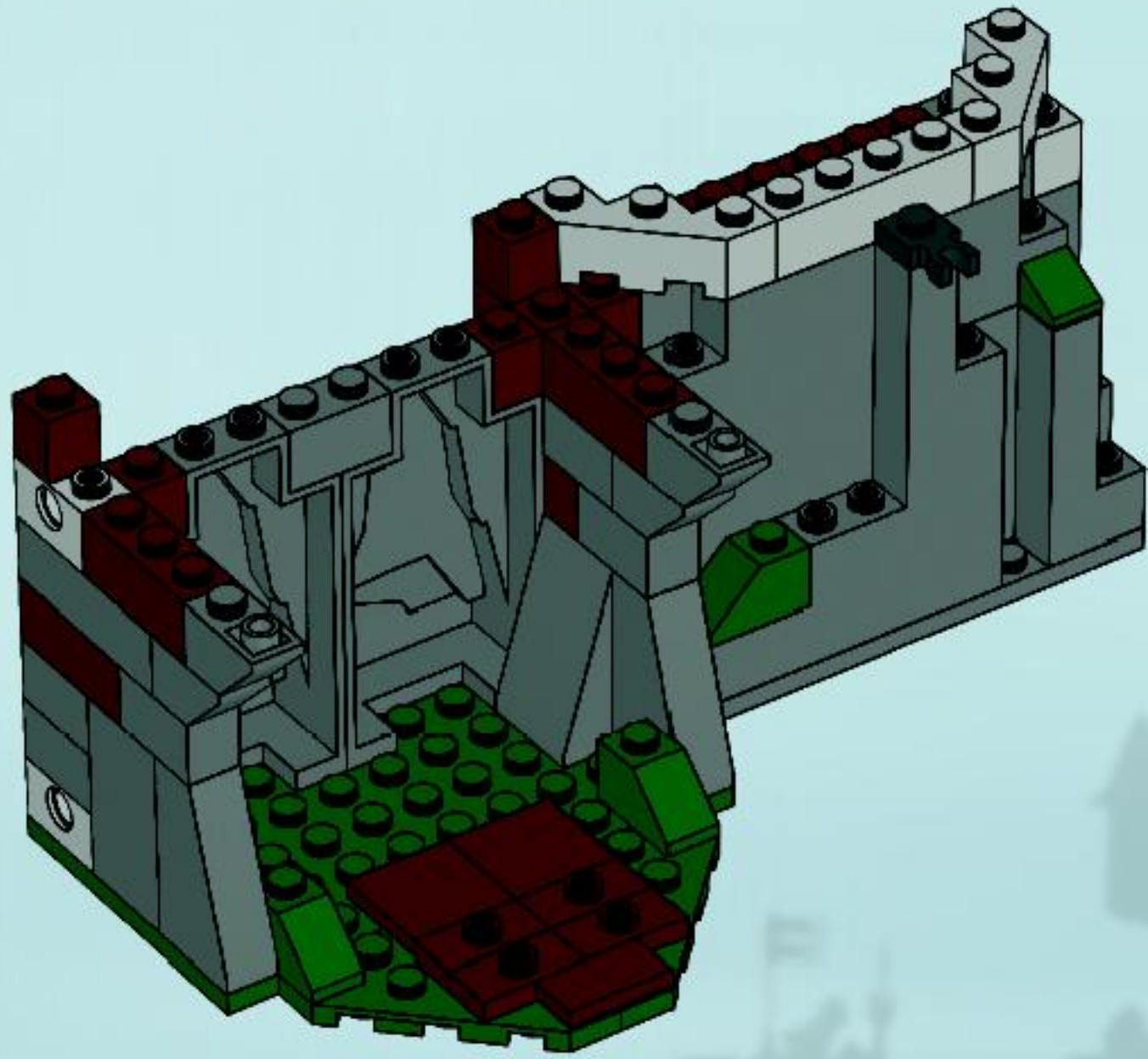

16

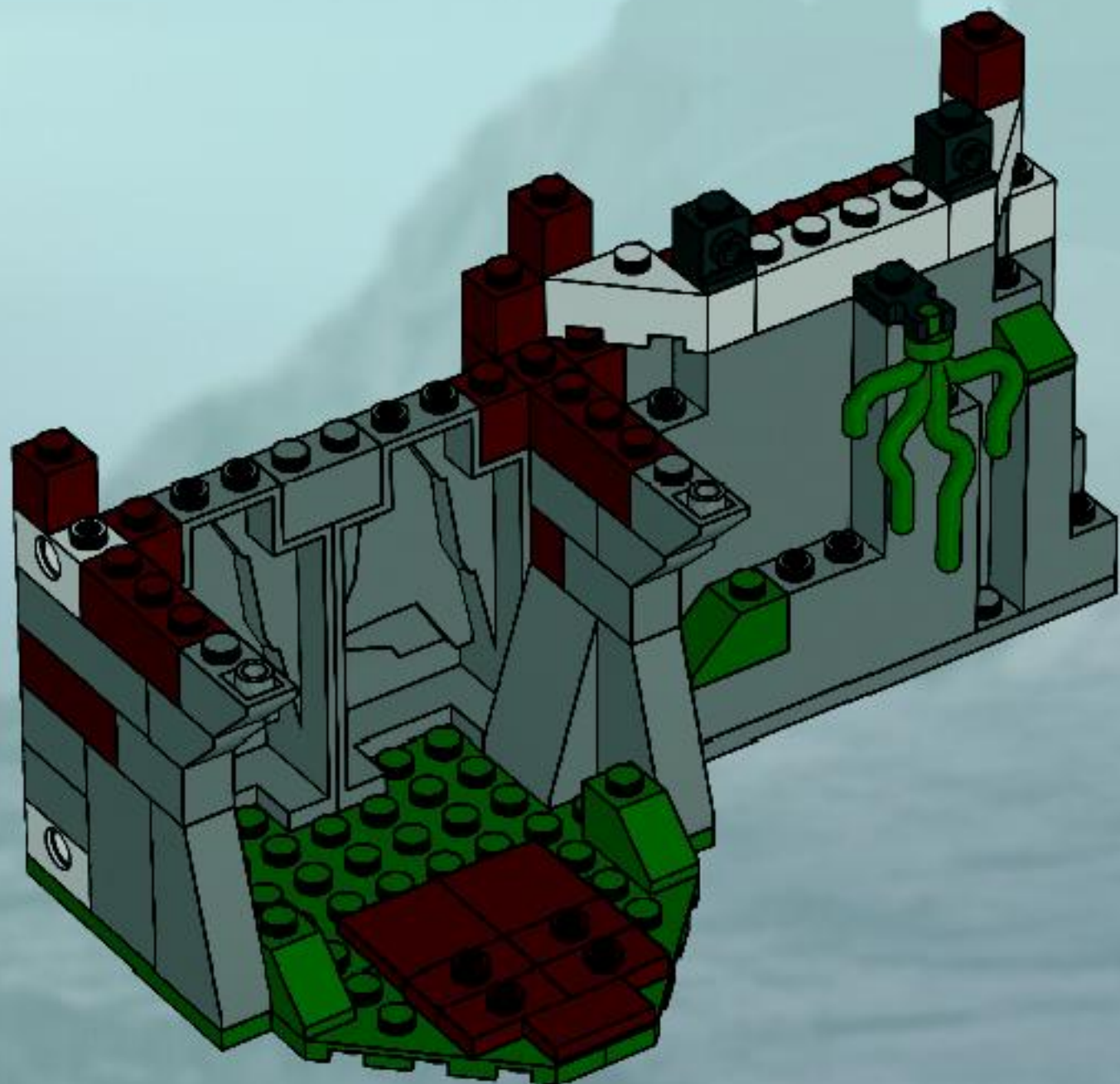



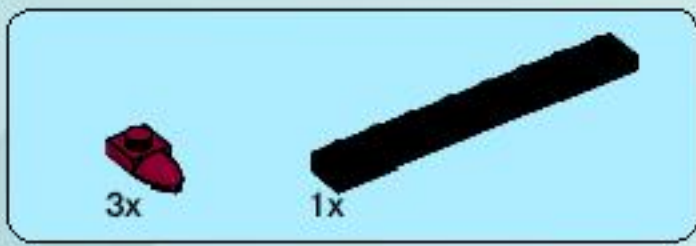

17

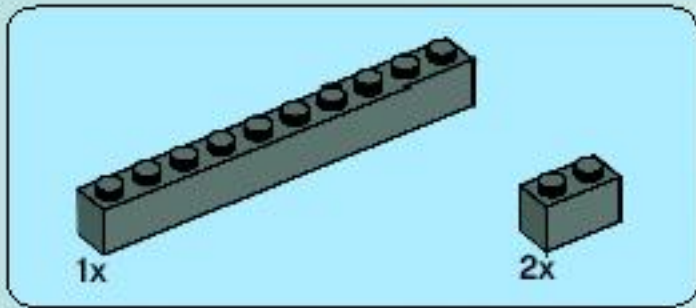
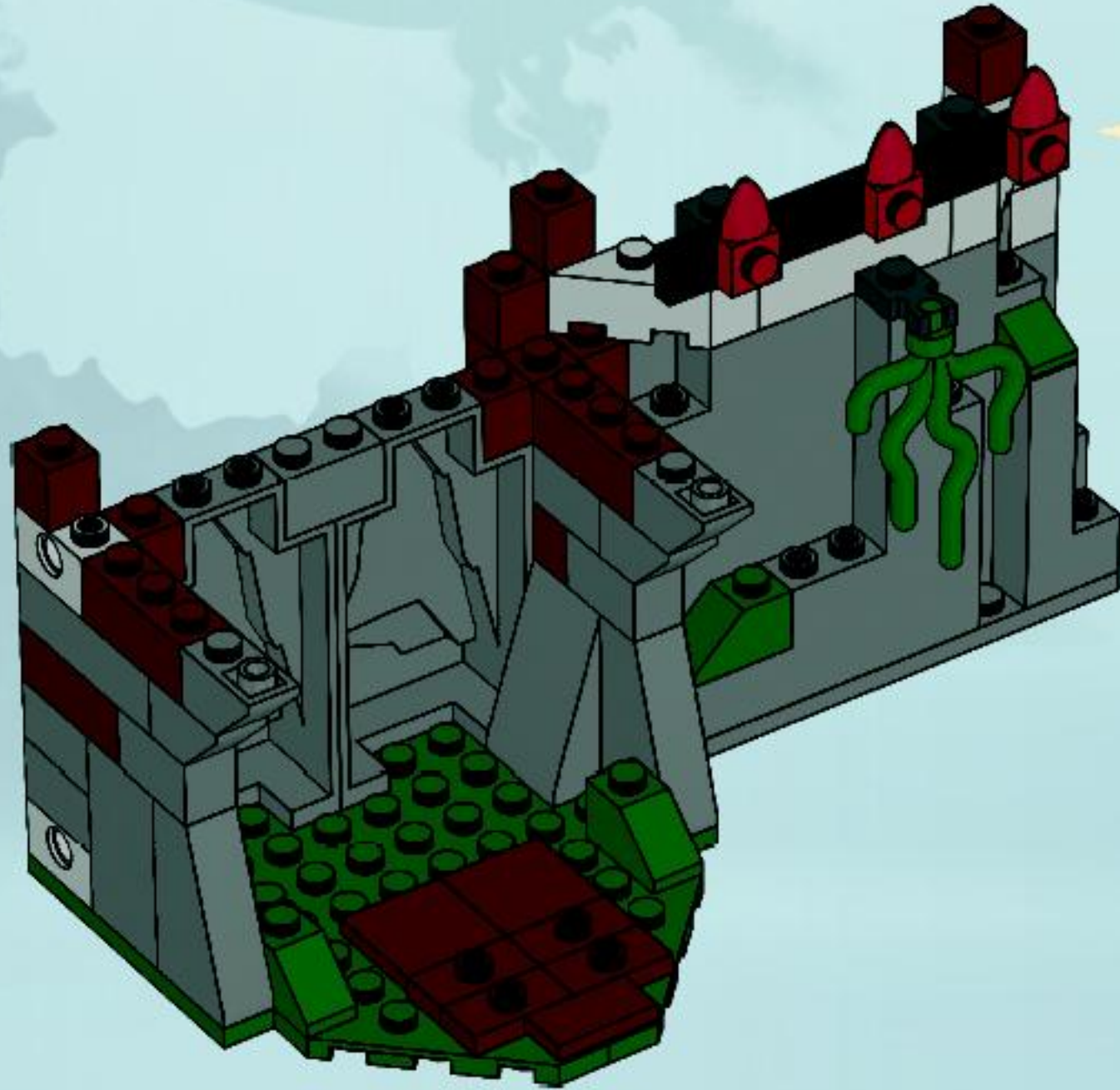
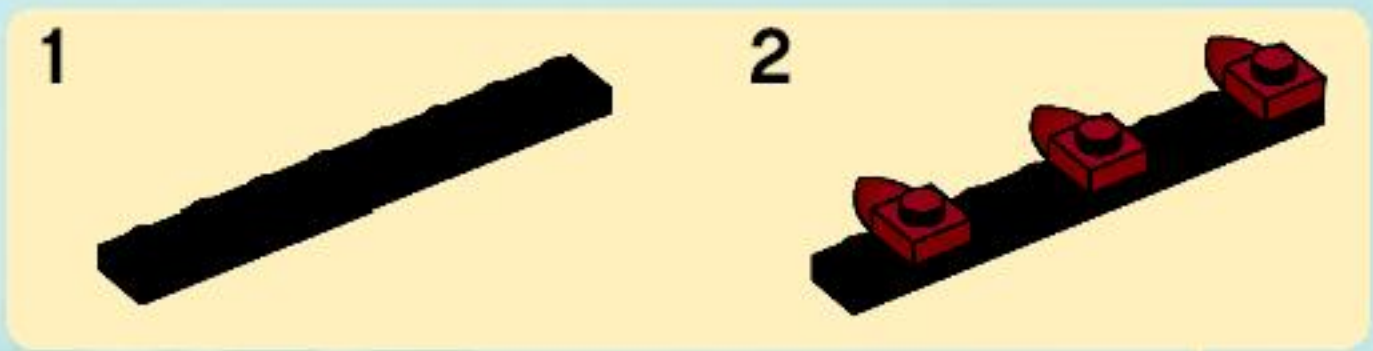

18

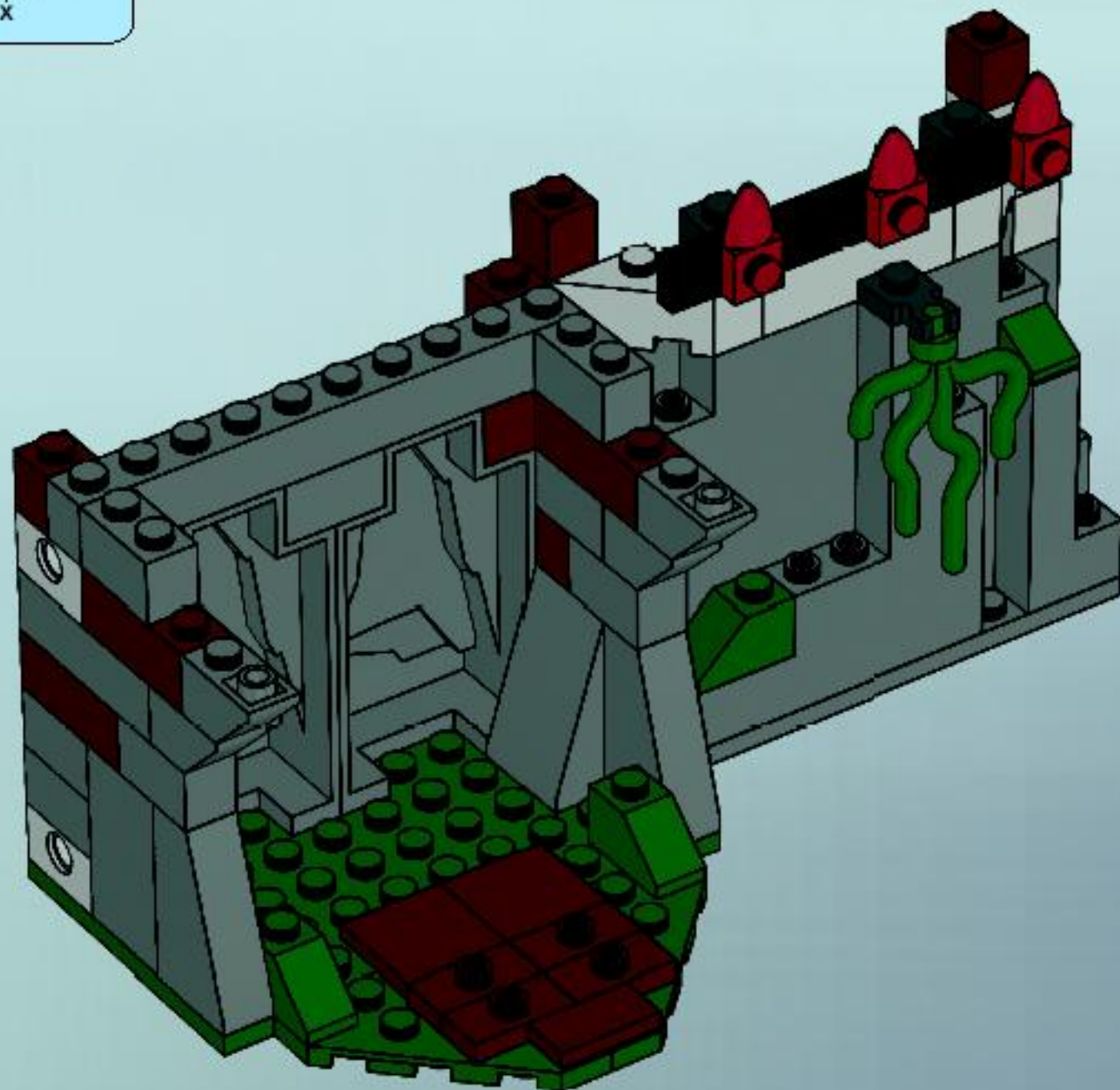





# 19

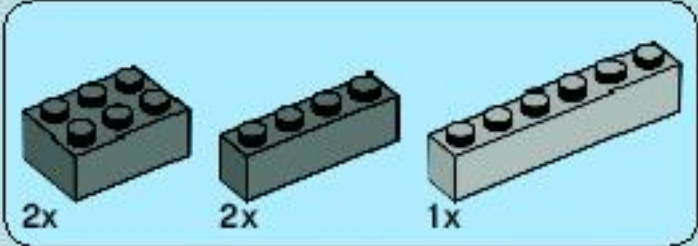
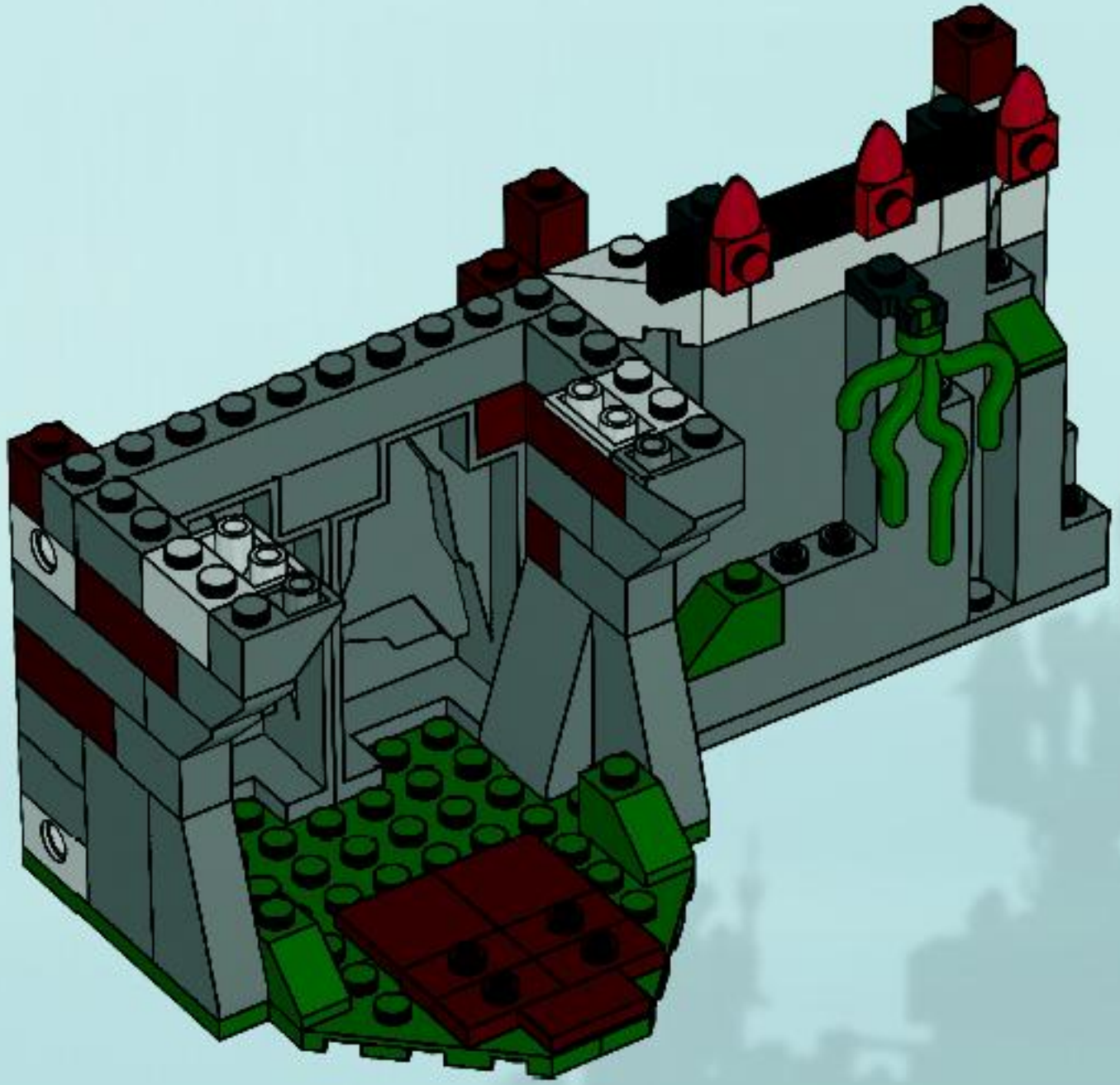

# 20

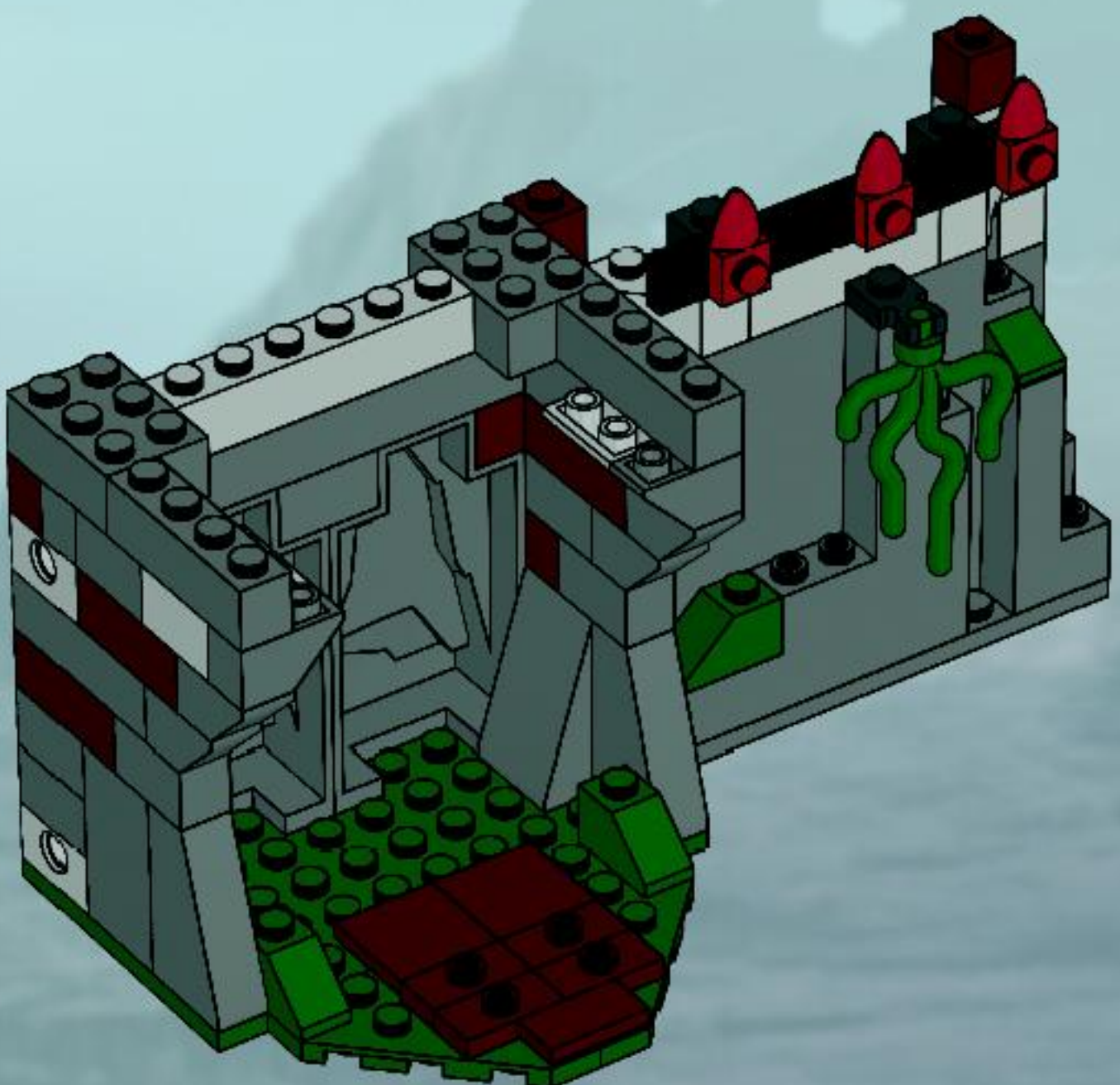



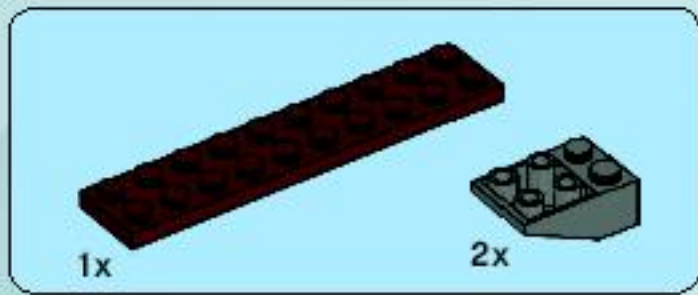

21

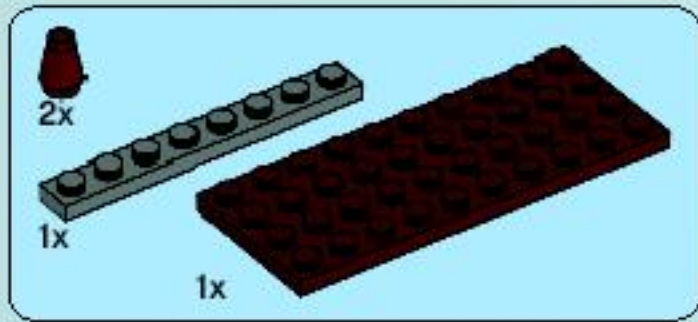
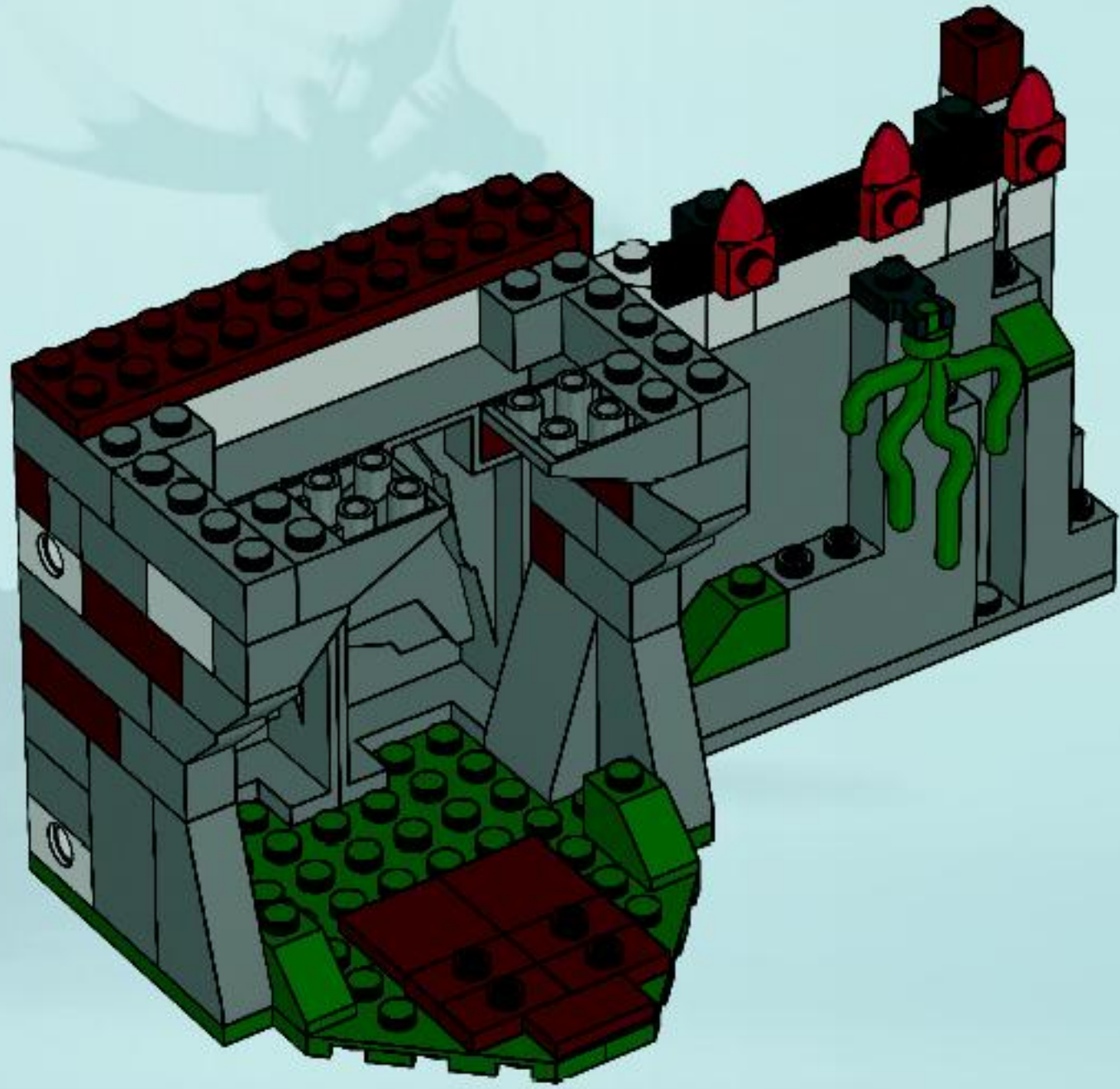

22

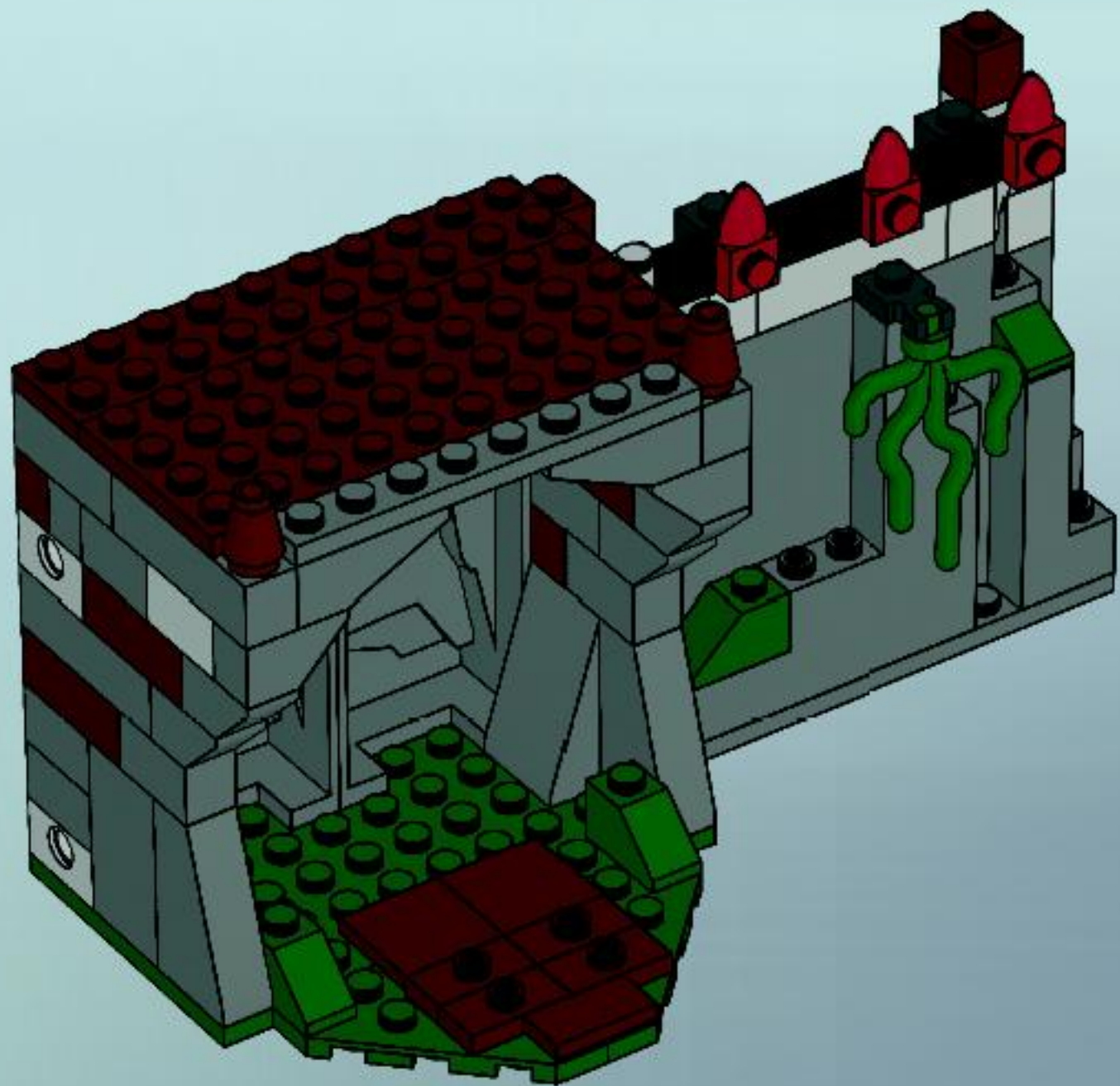



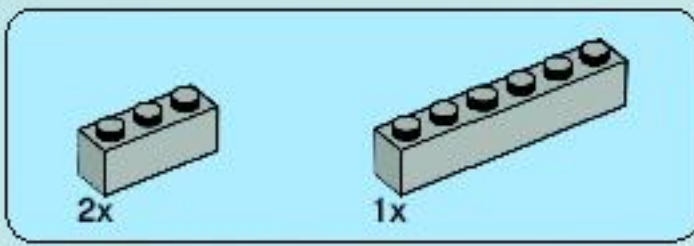

23

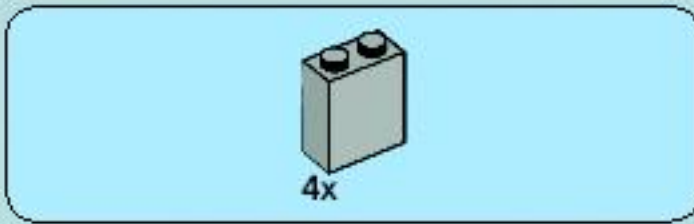
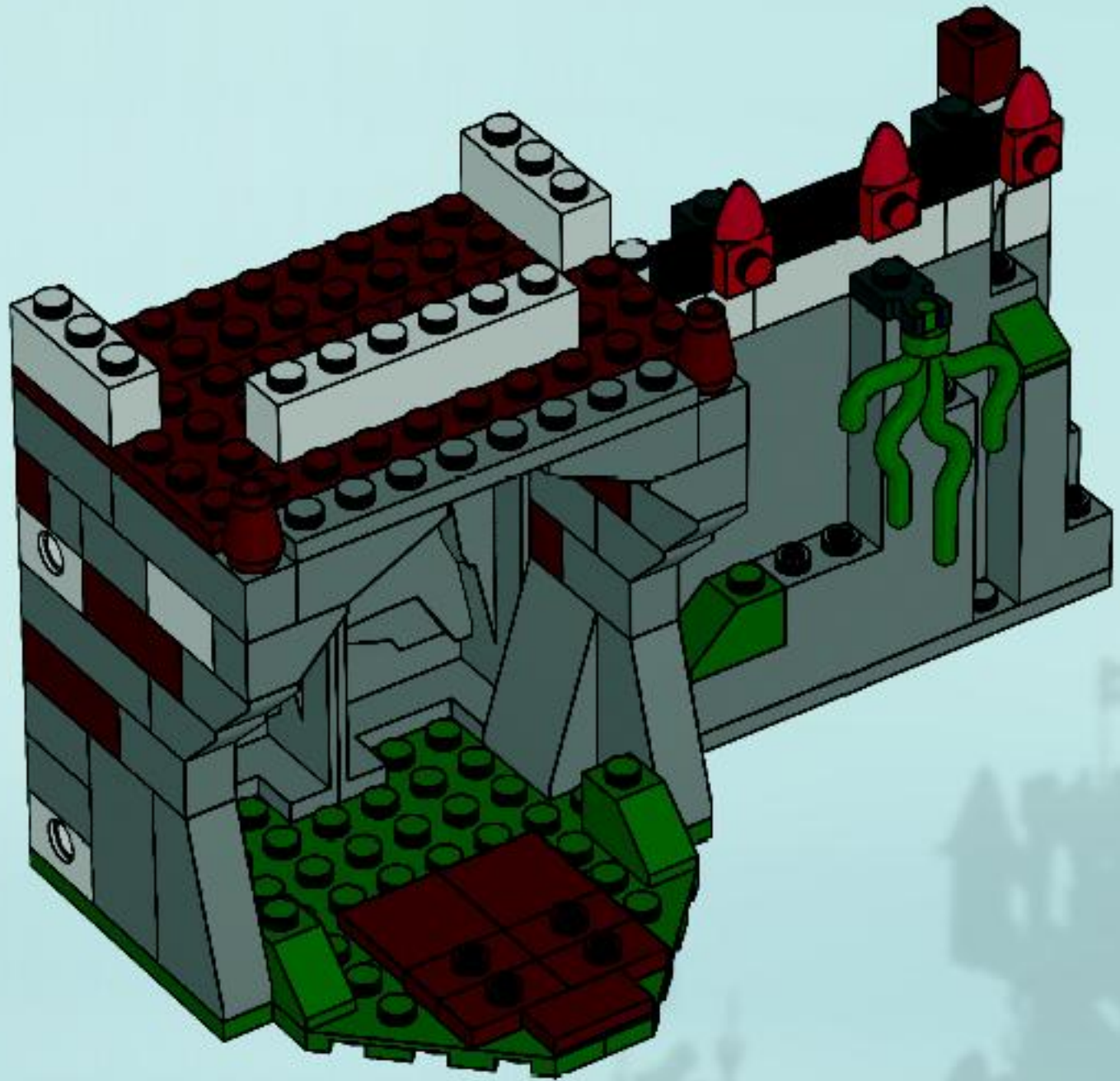

24

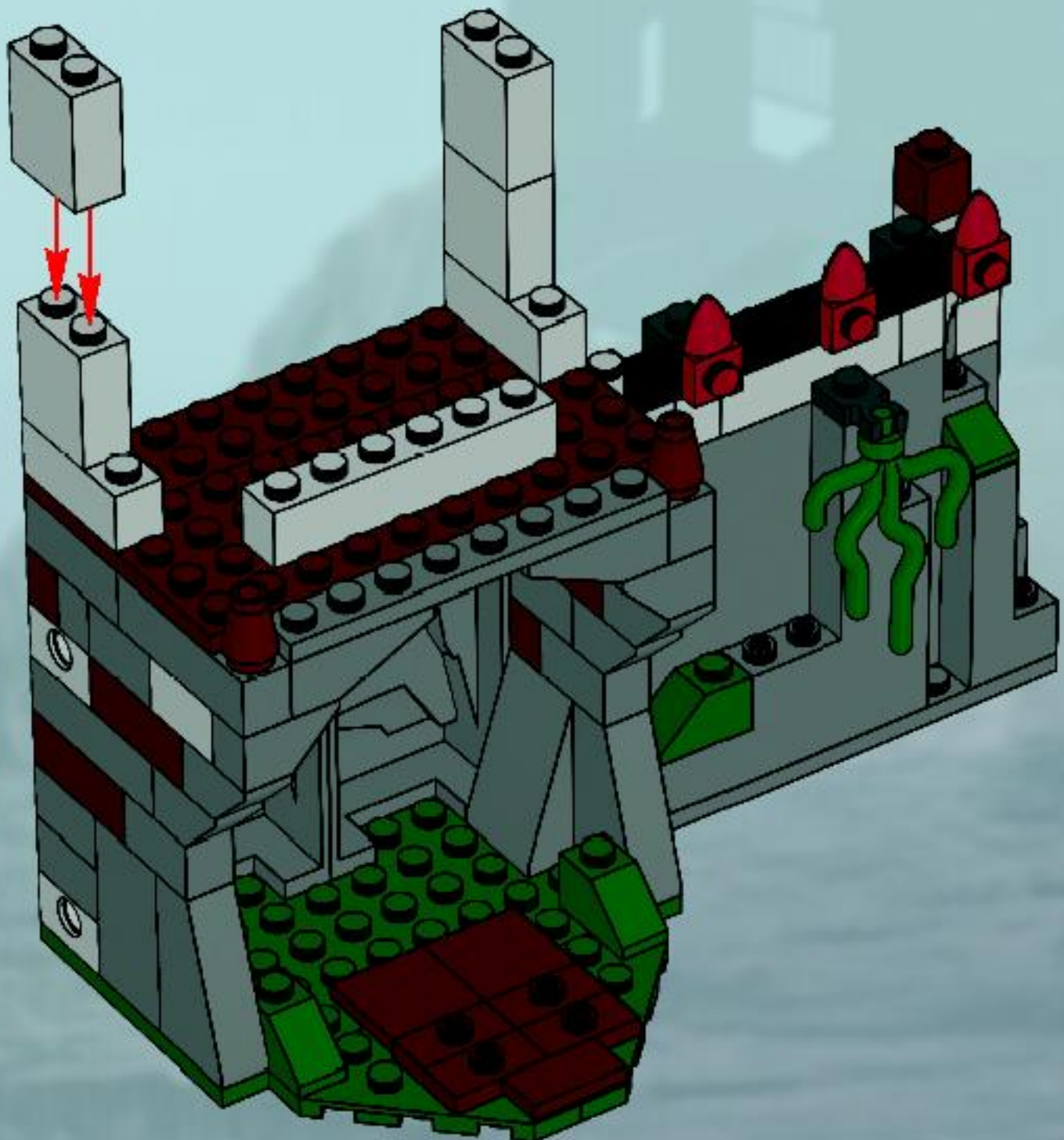



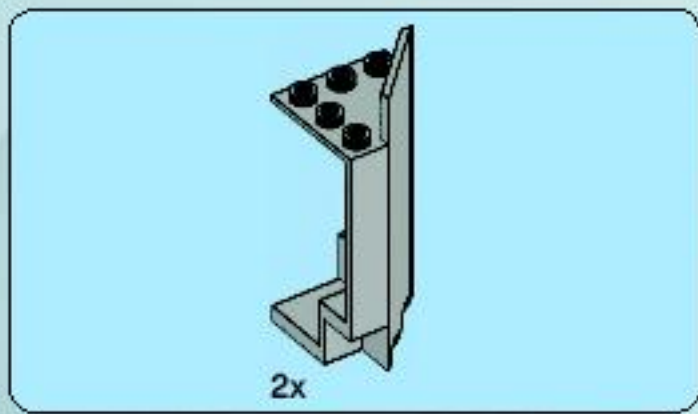

25

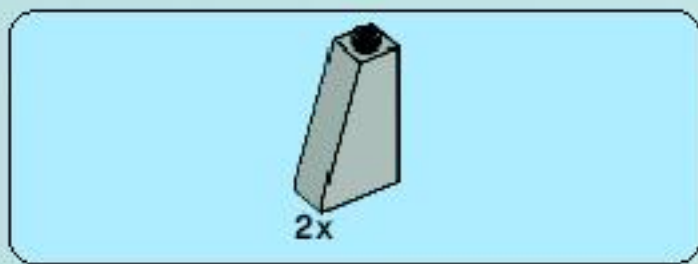
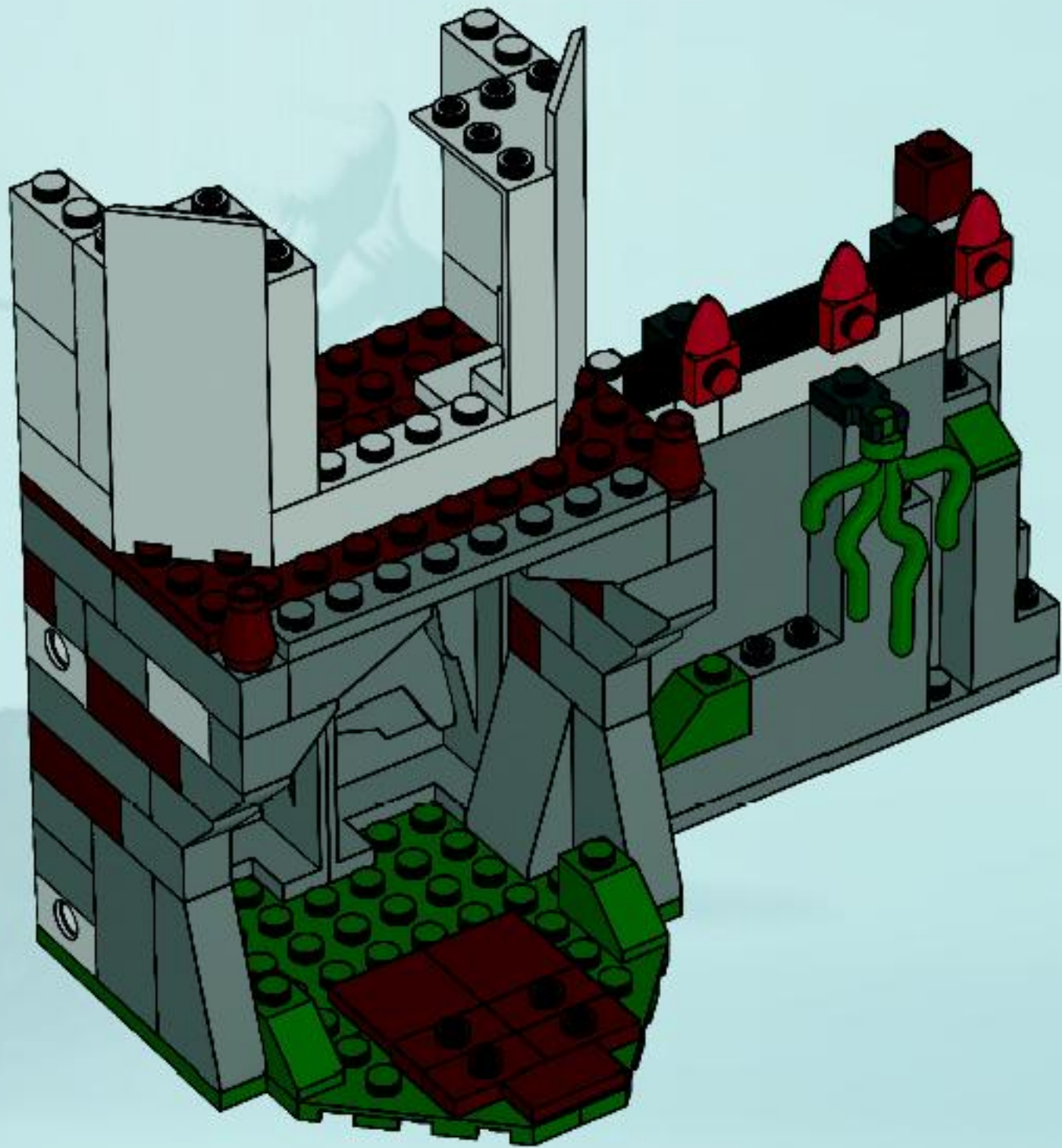

26

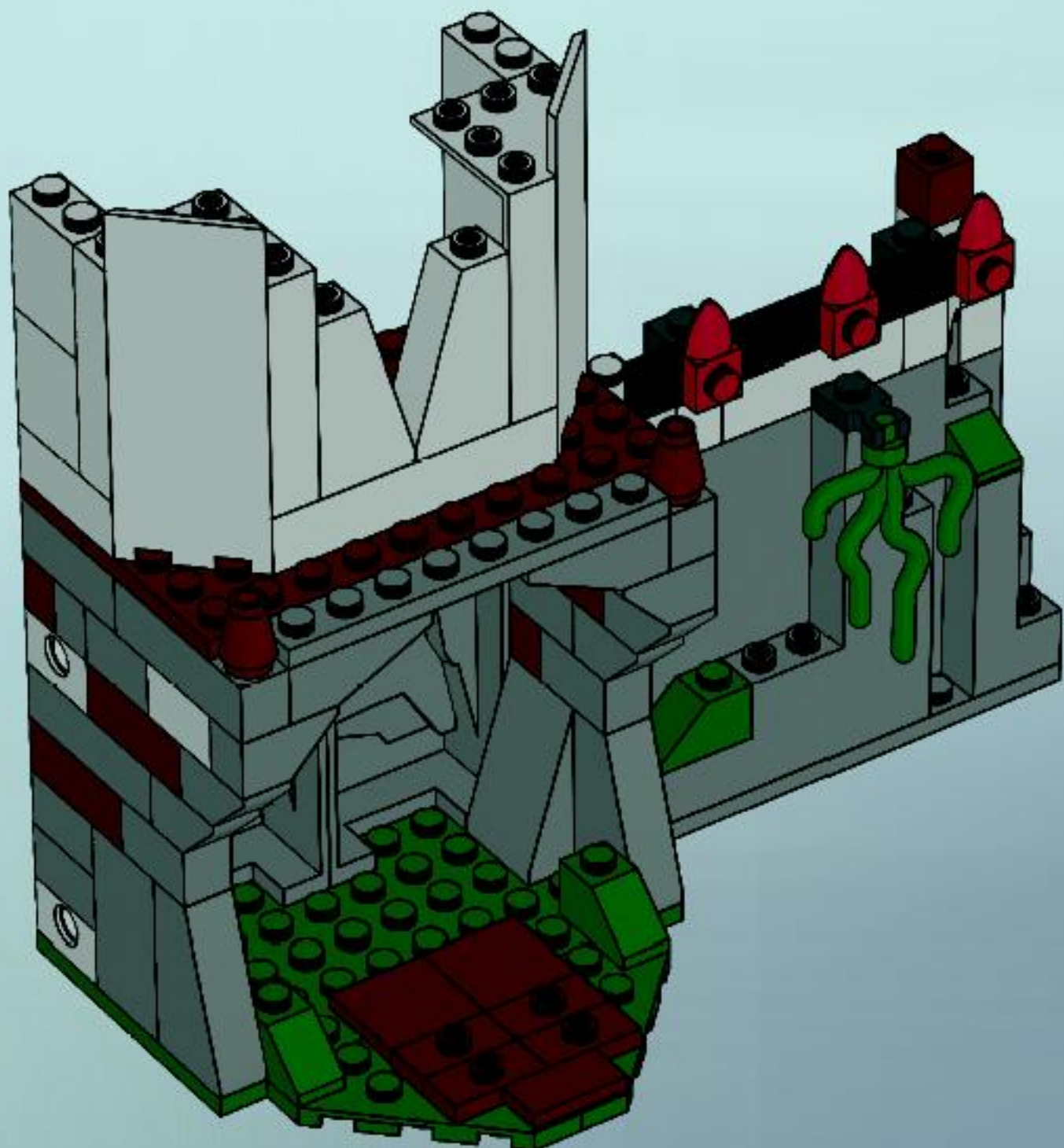



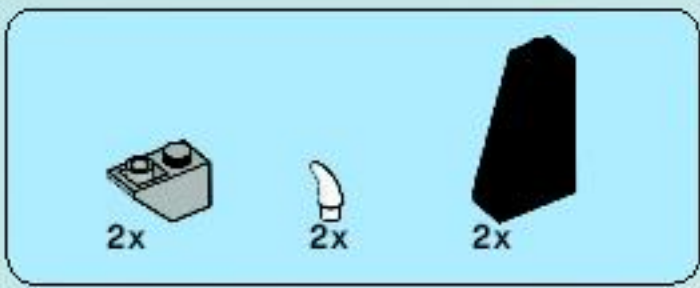

27

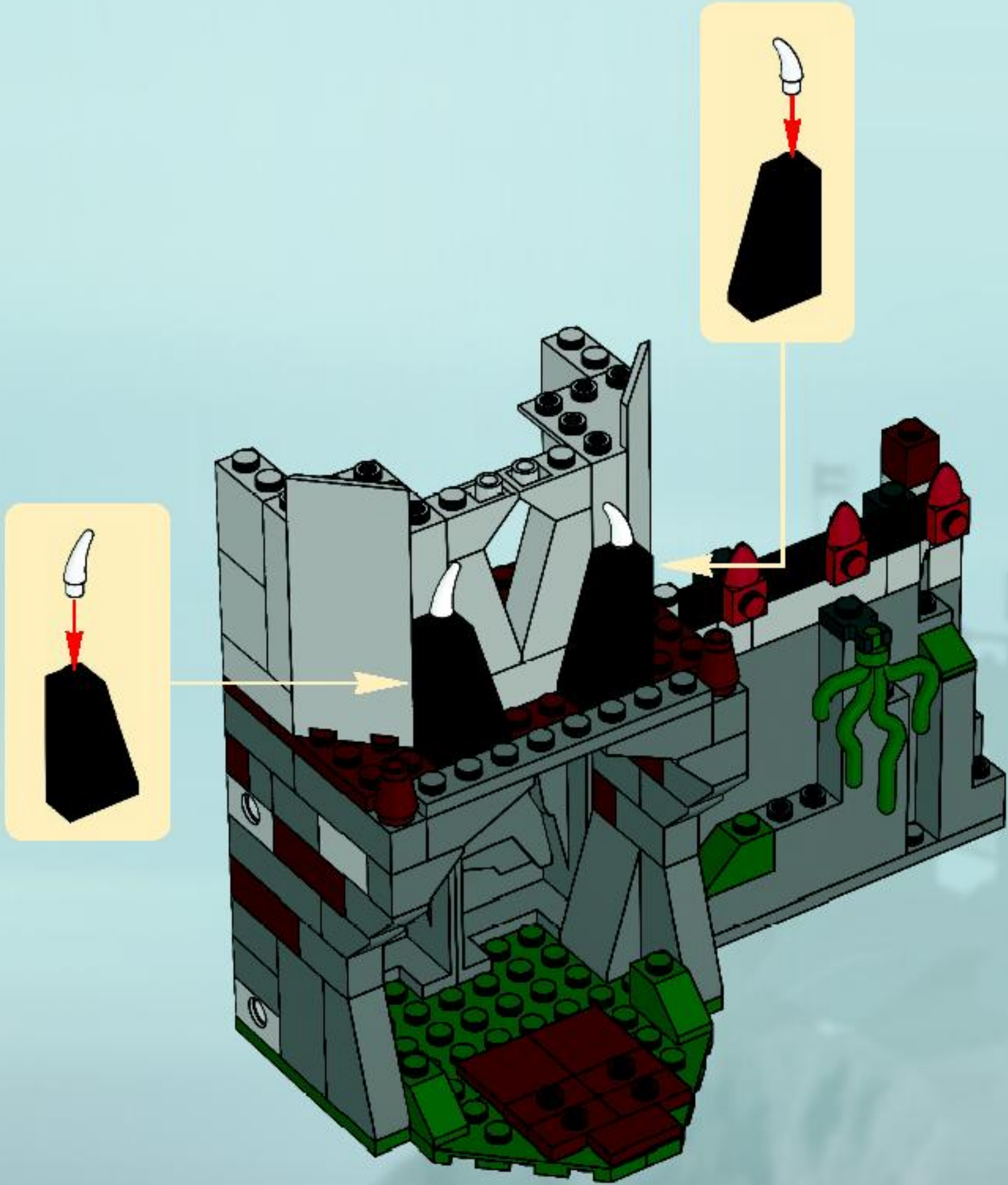



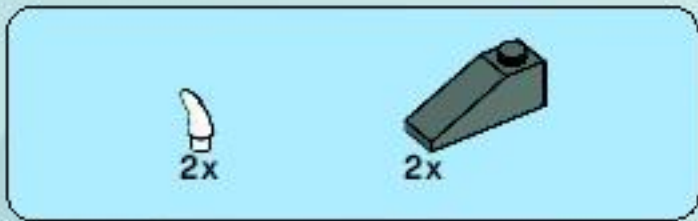

28

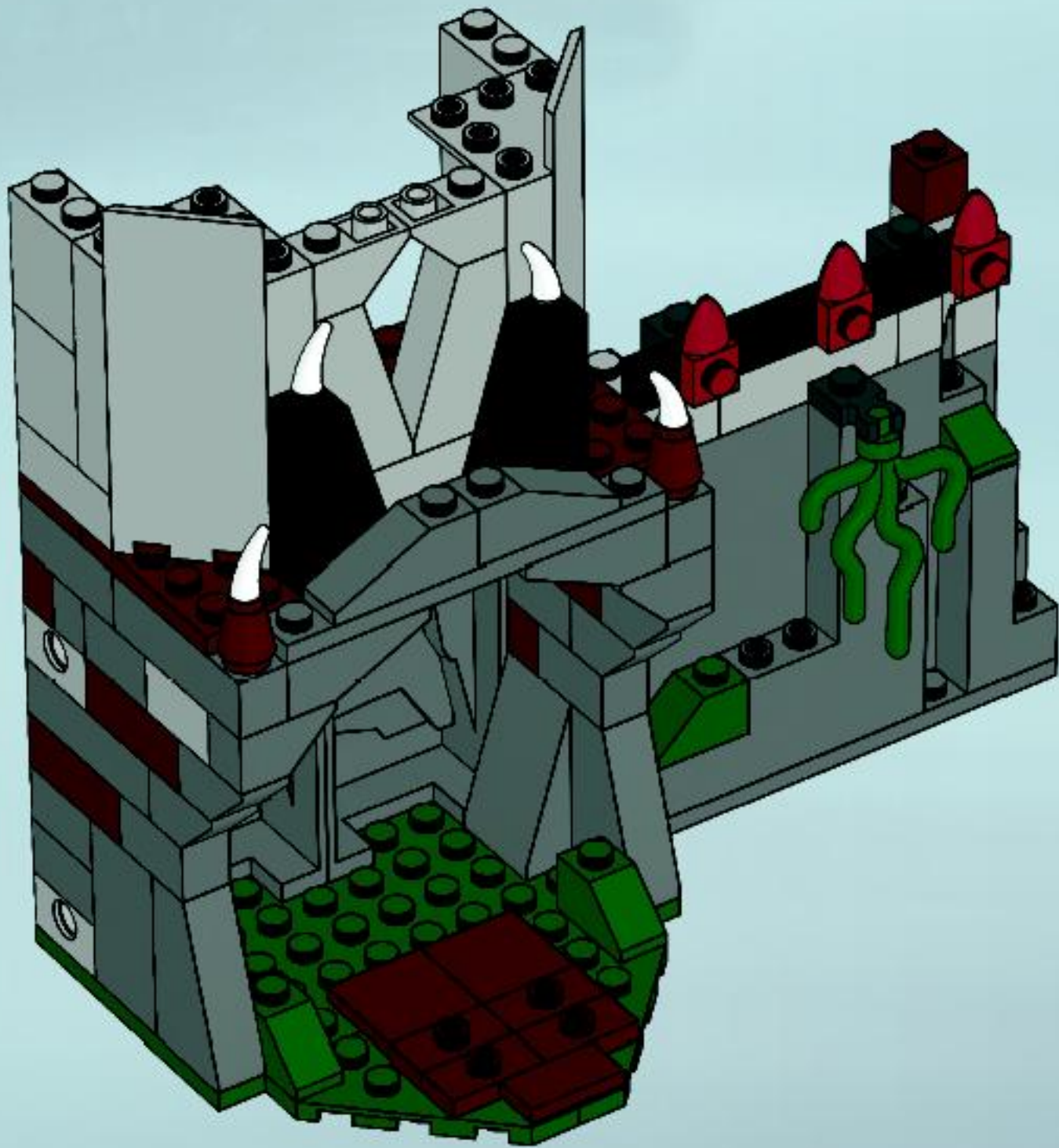





2x



4x

# 29

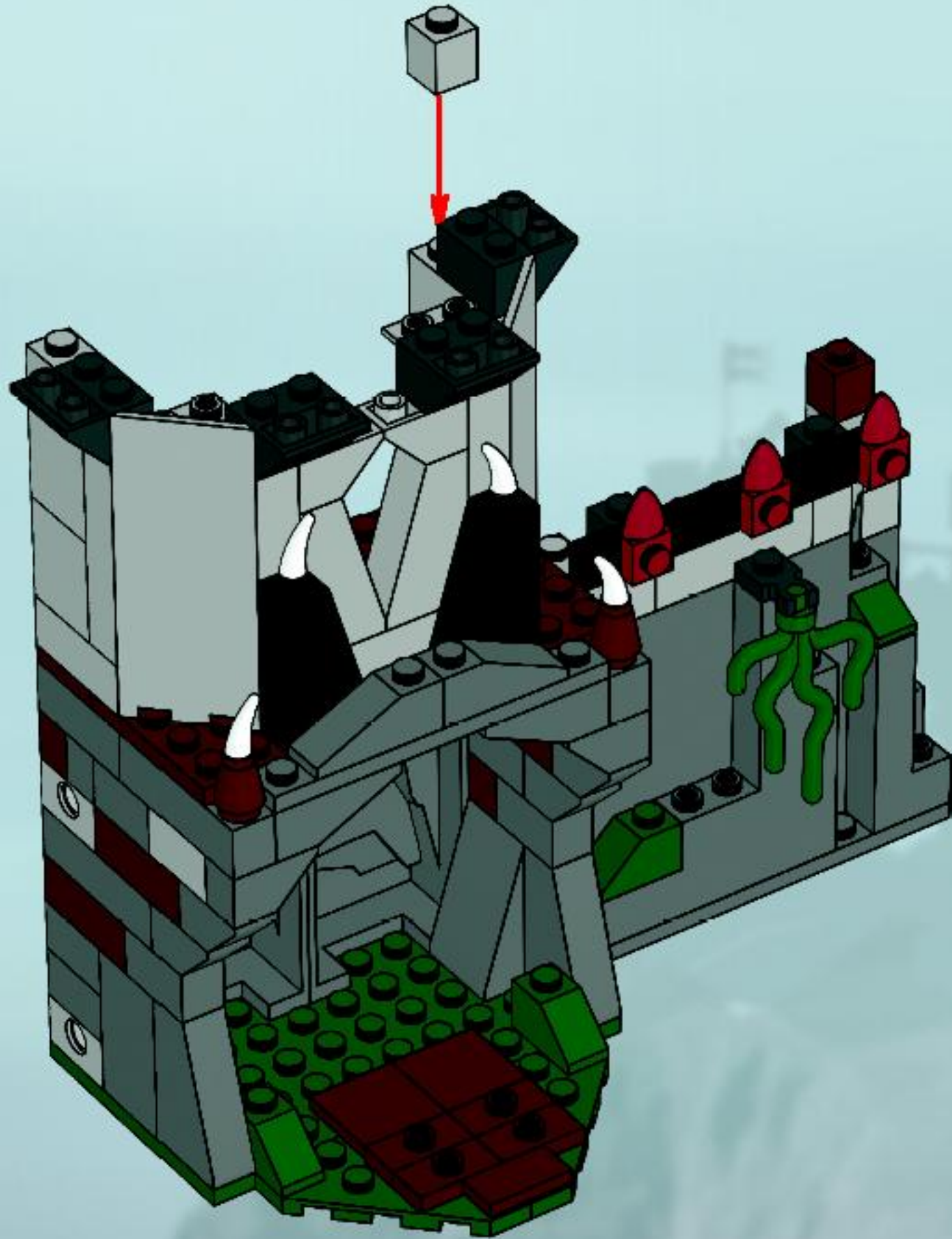



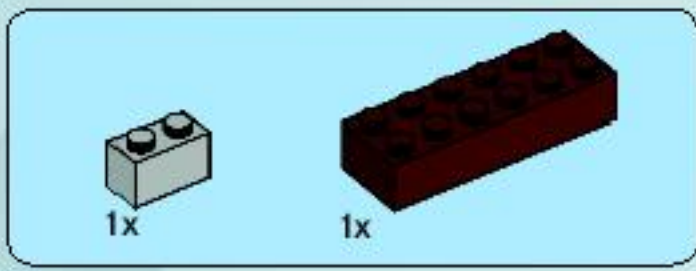

30

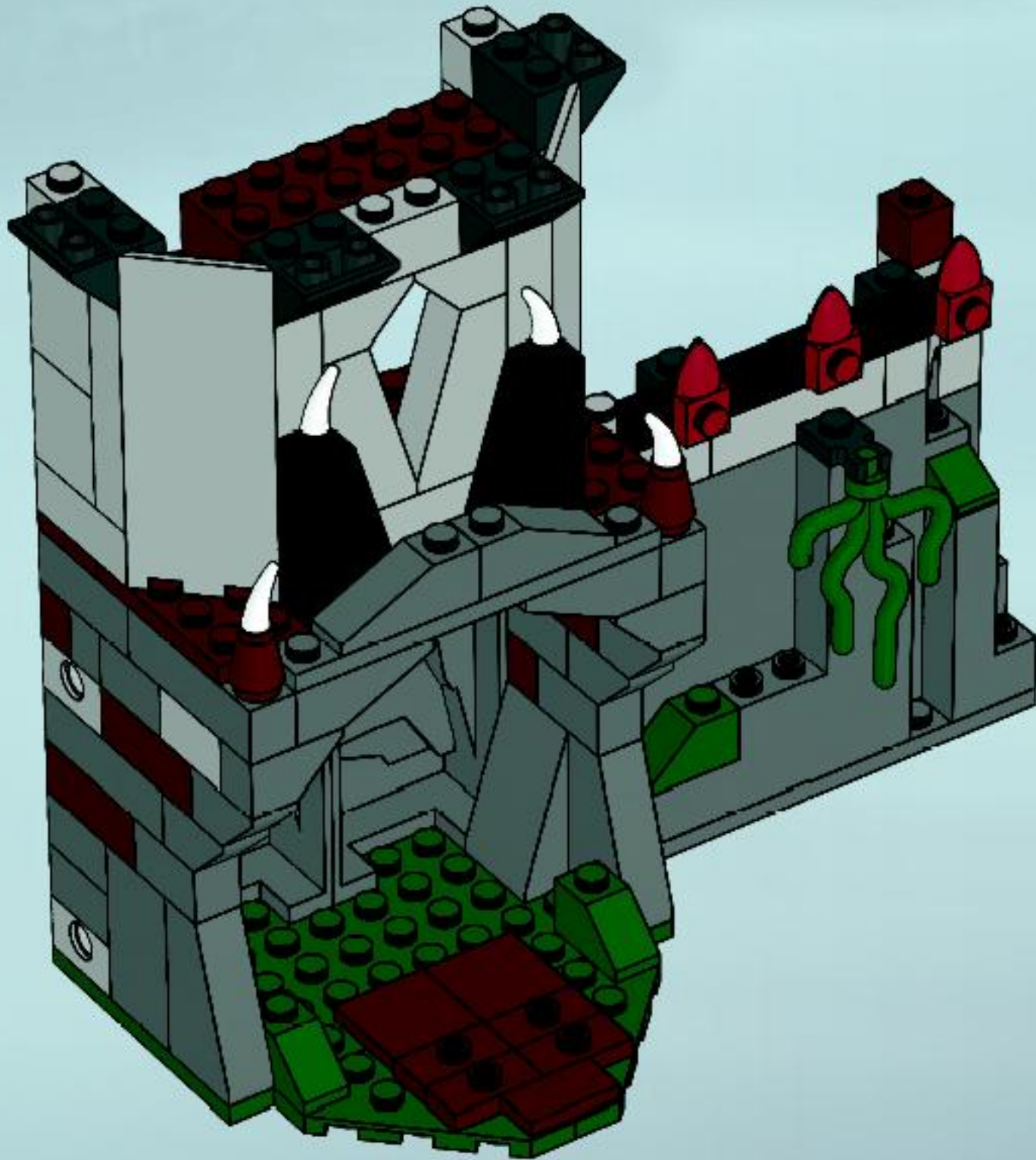



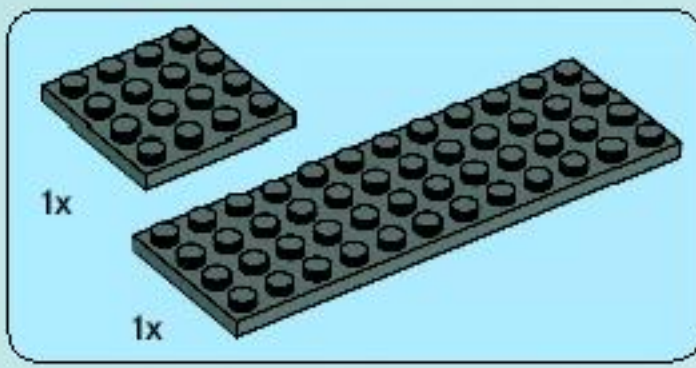

31

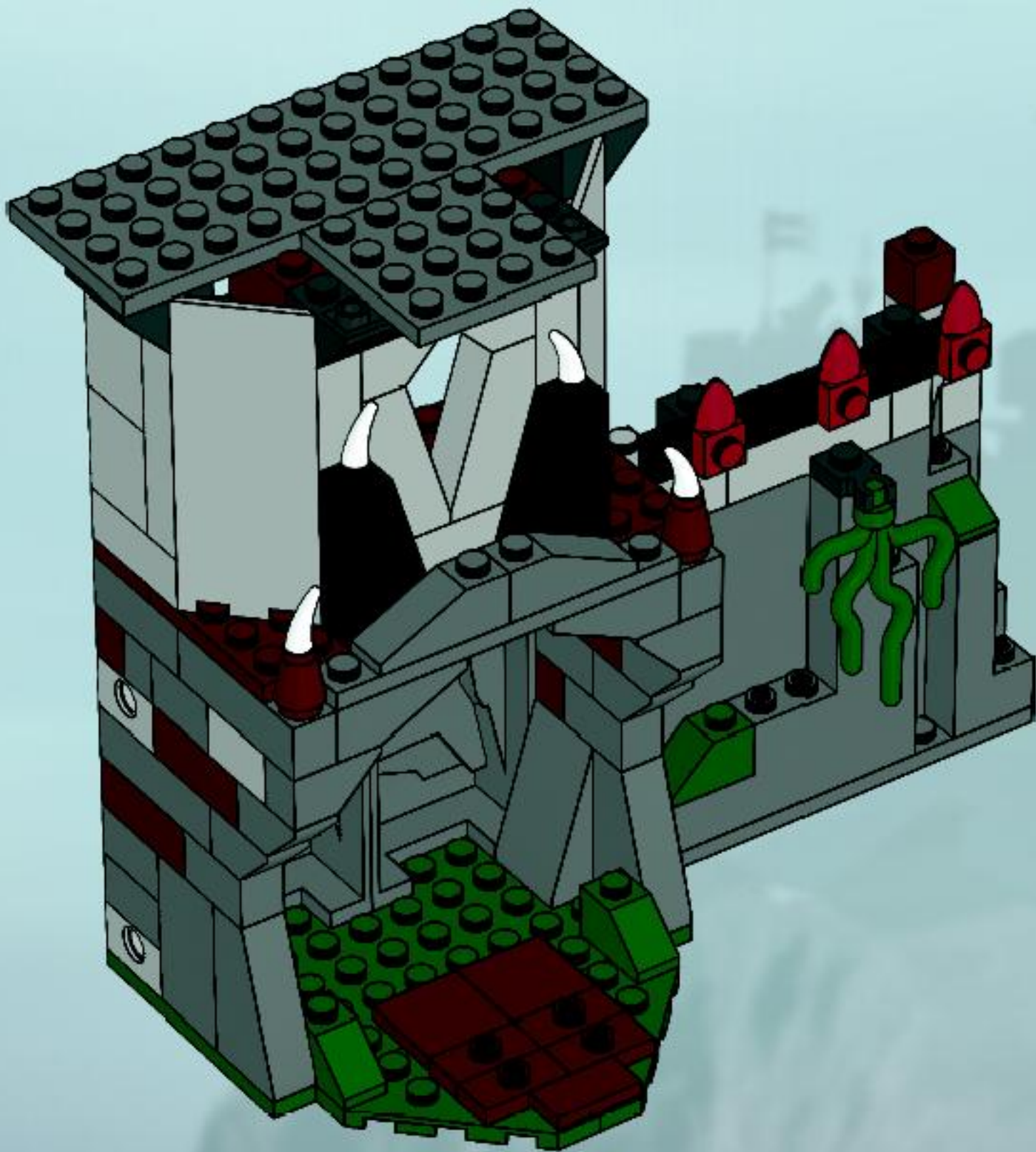





2x

# 32

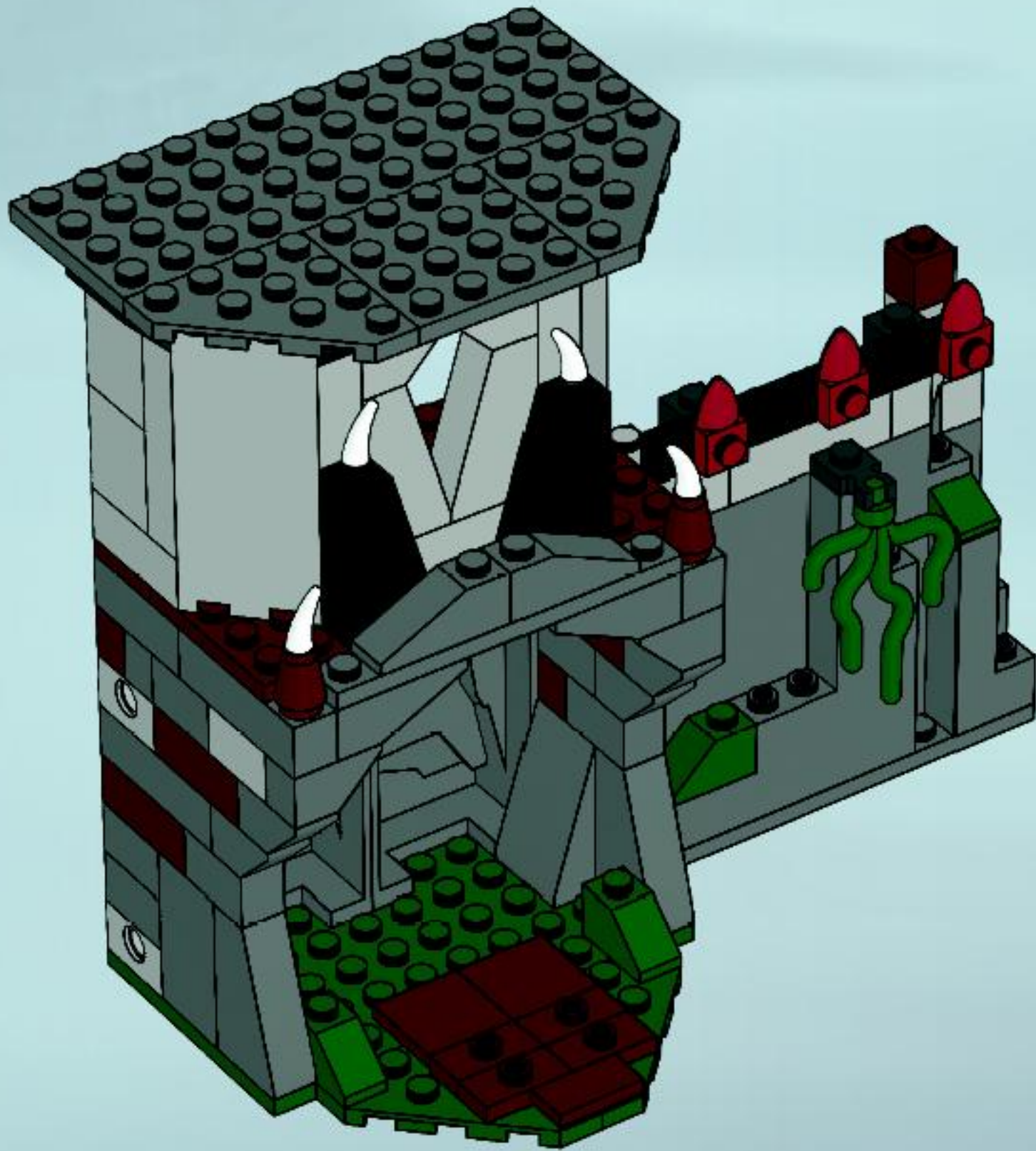



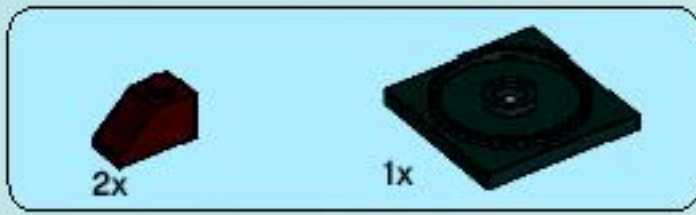

33

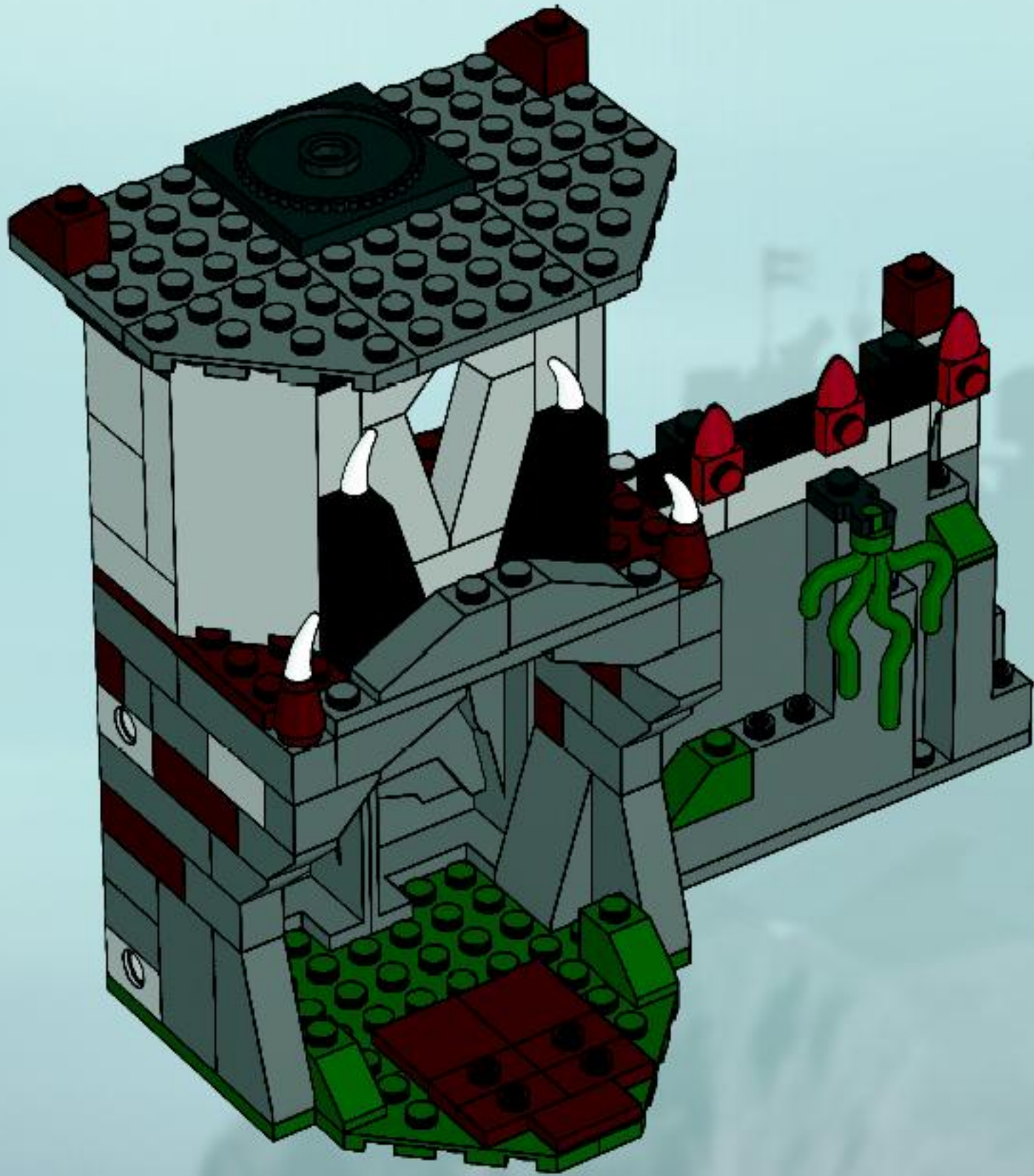





34

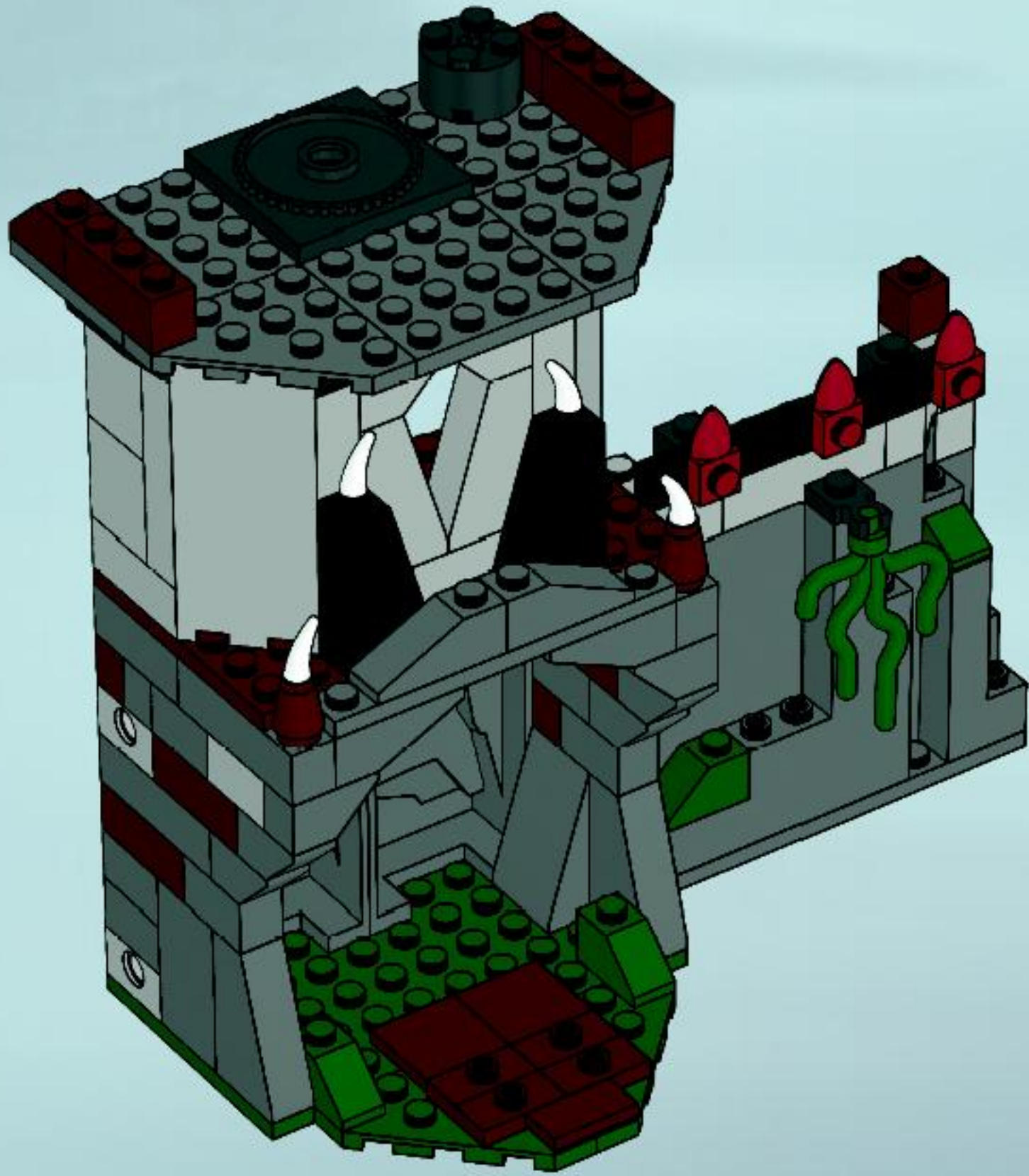





35

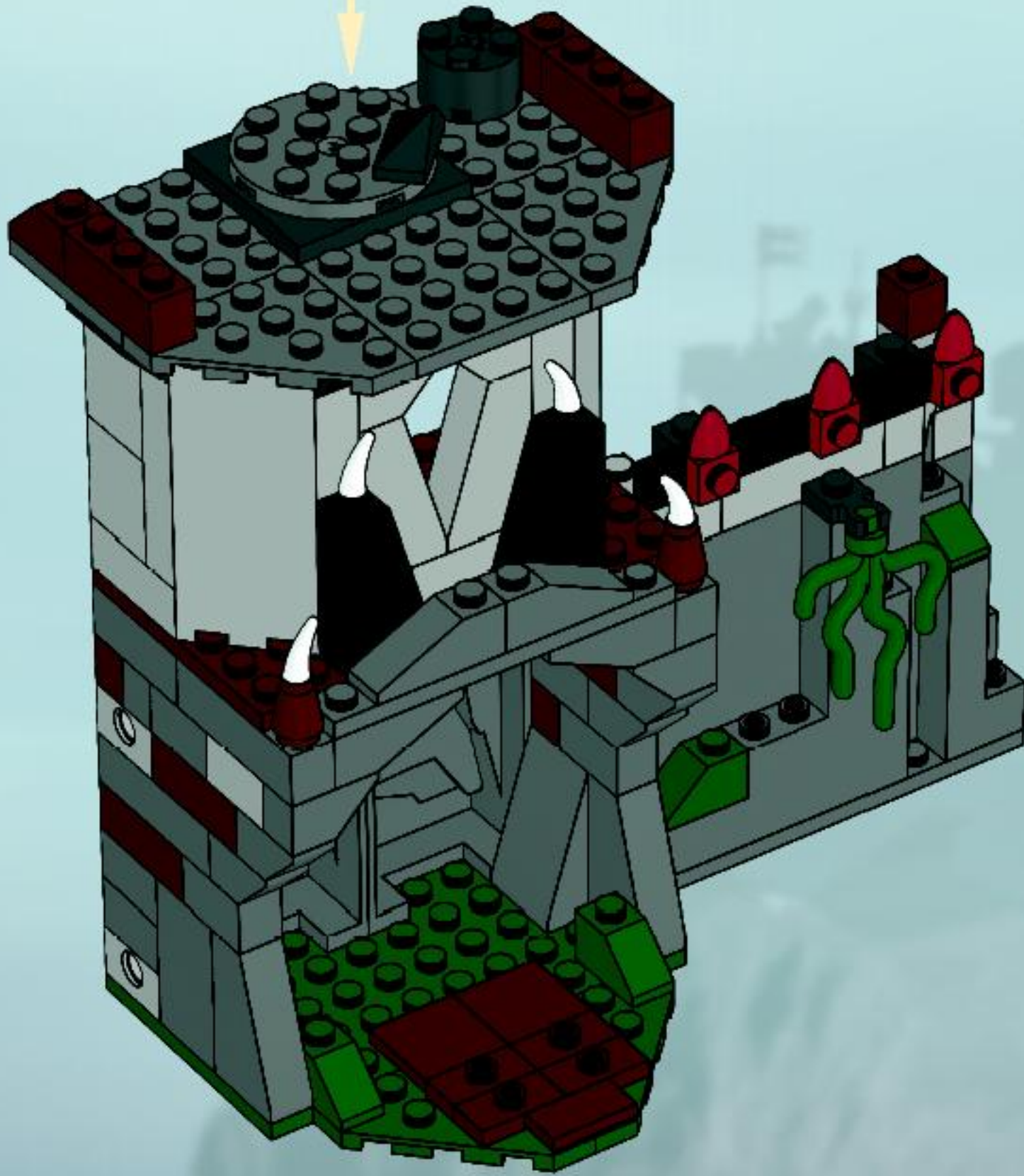



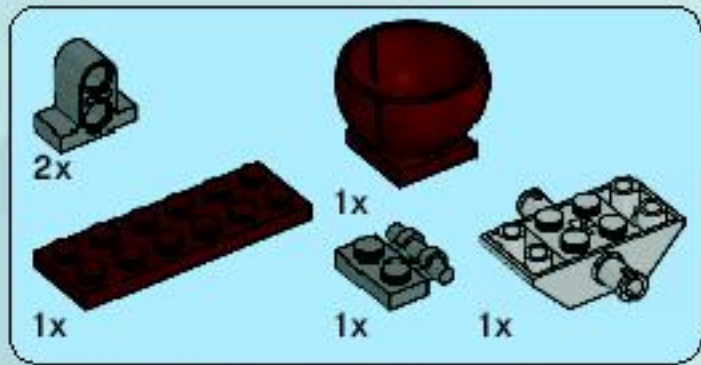

36

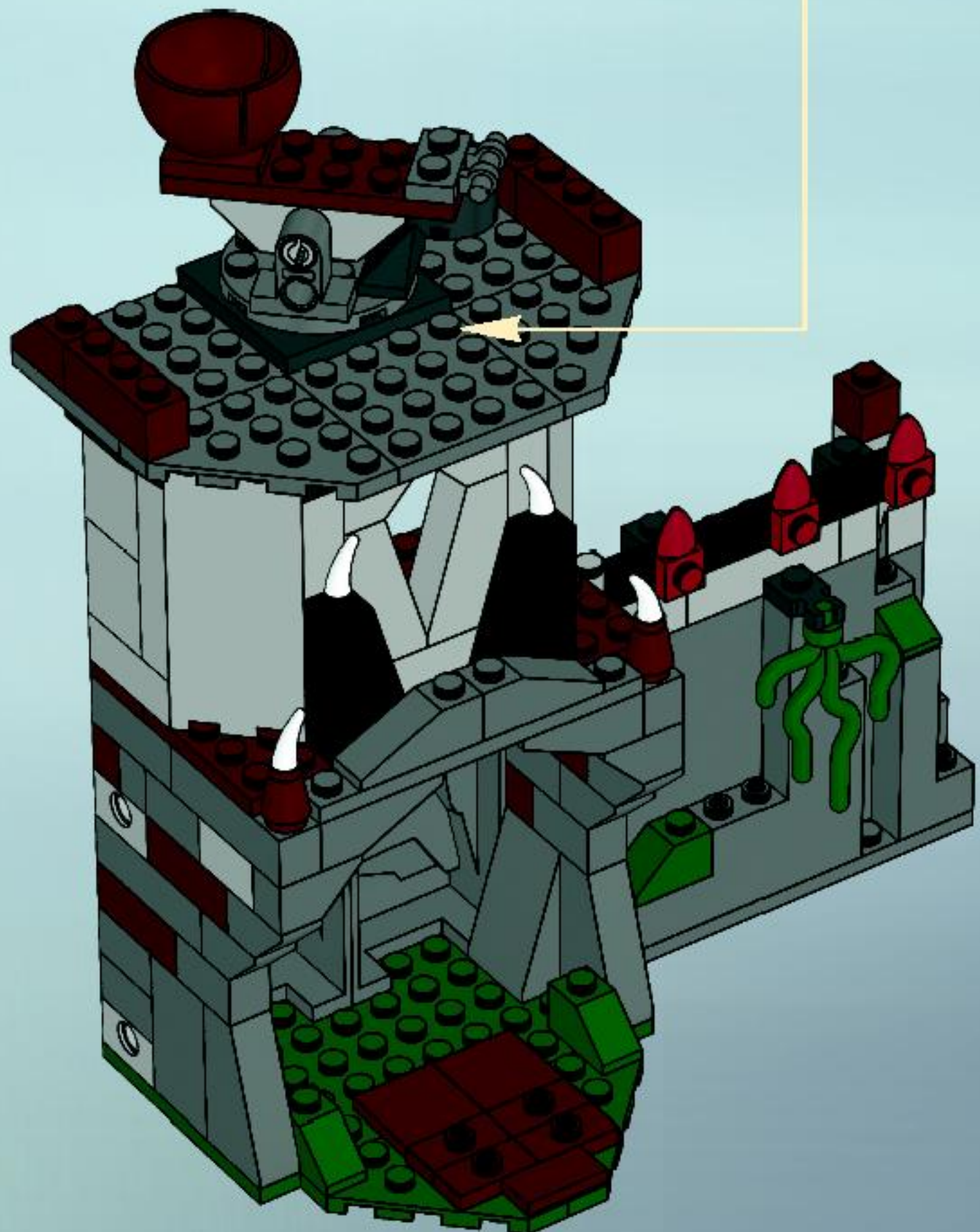
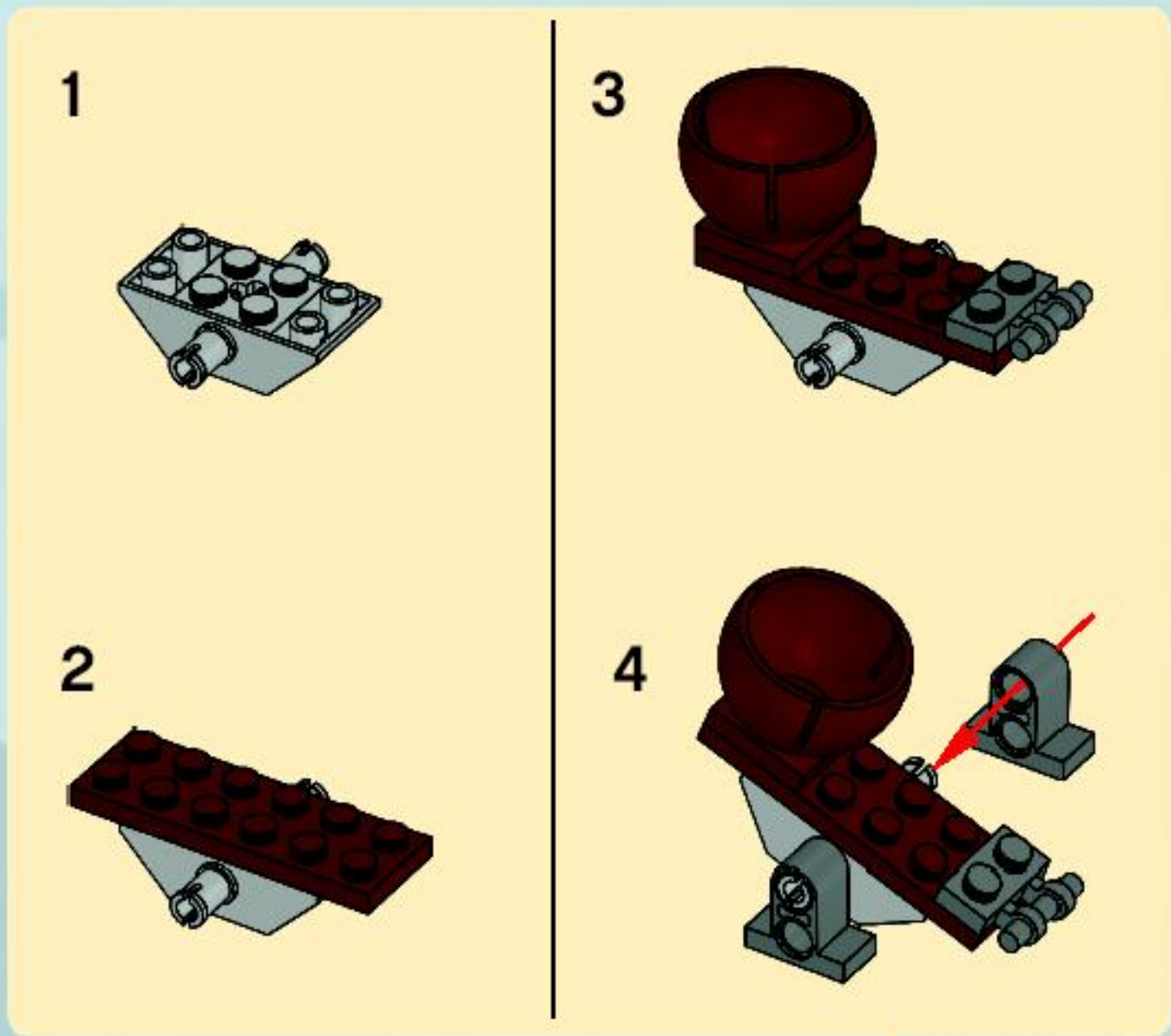



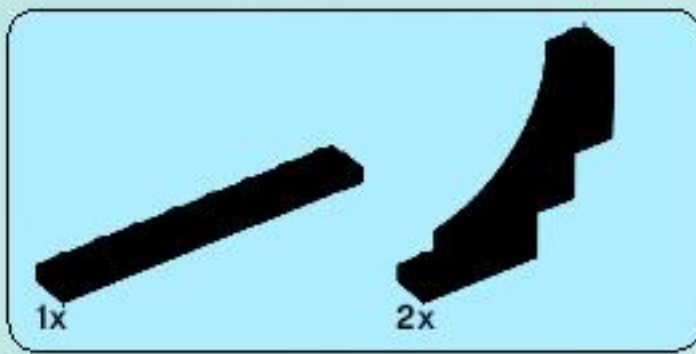

37

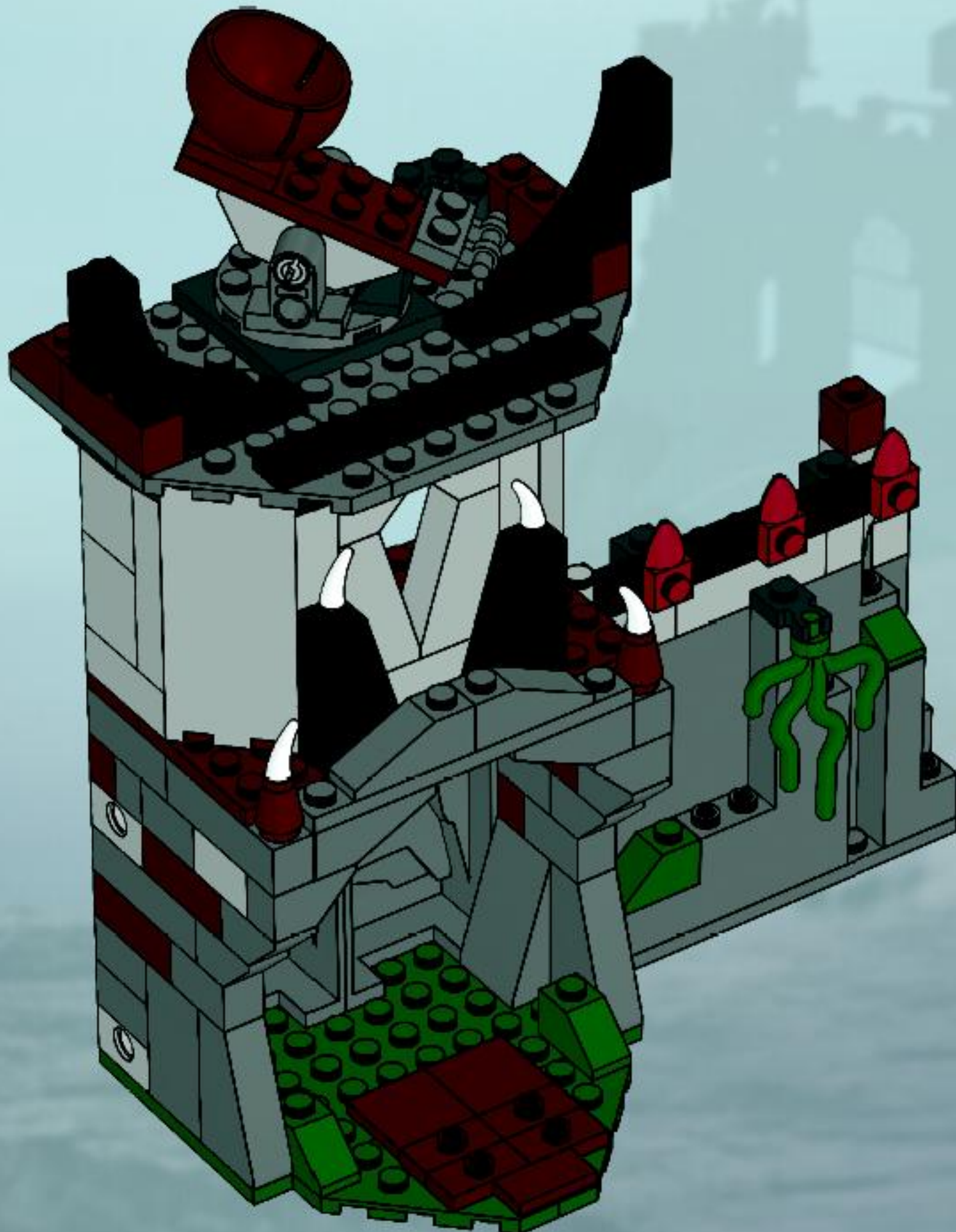



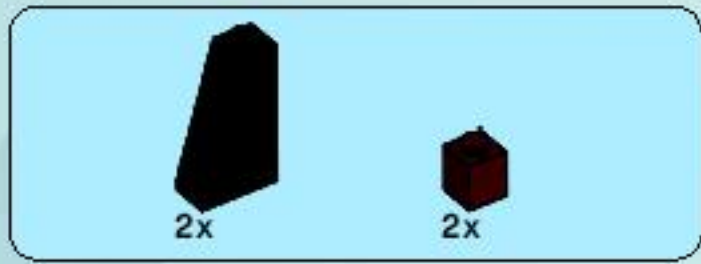

38

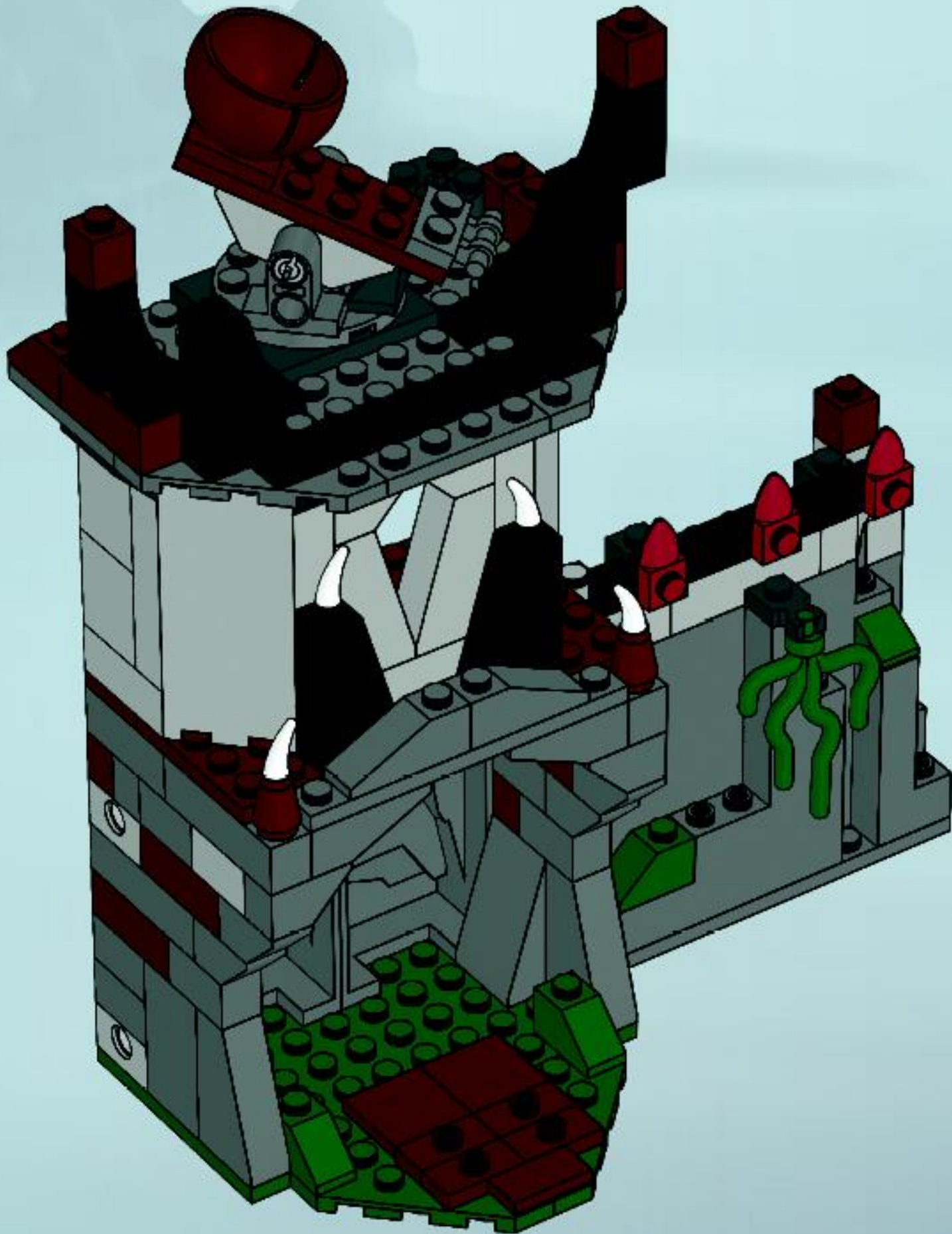



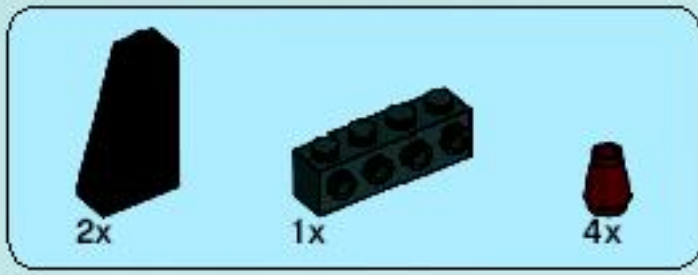

39







4x

# 40





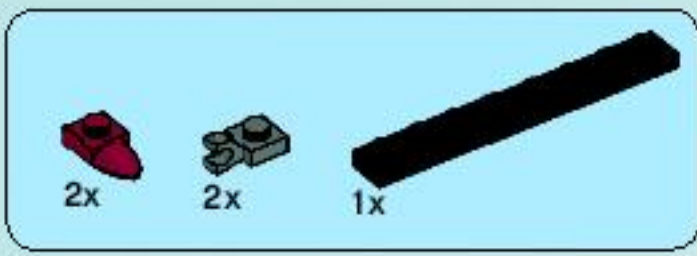

41

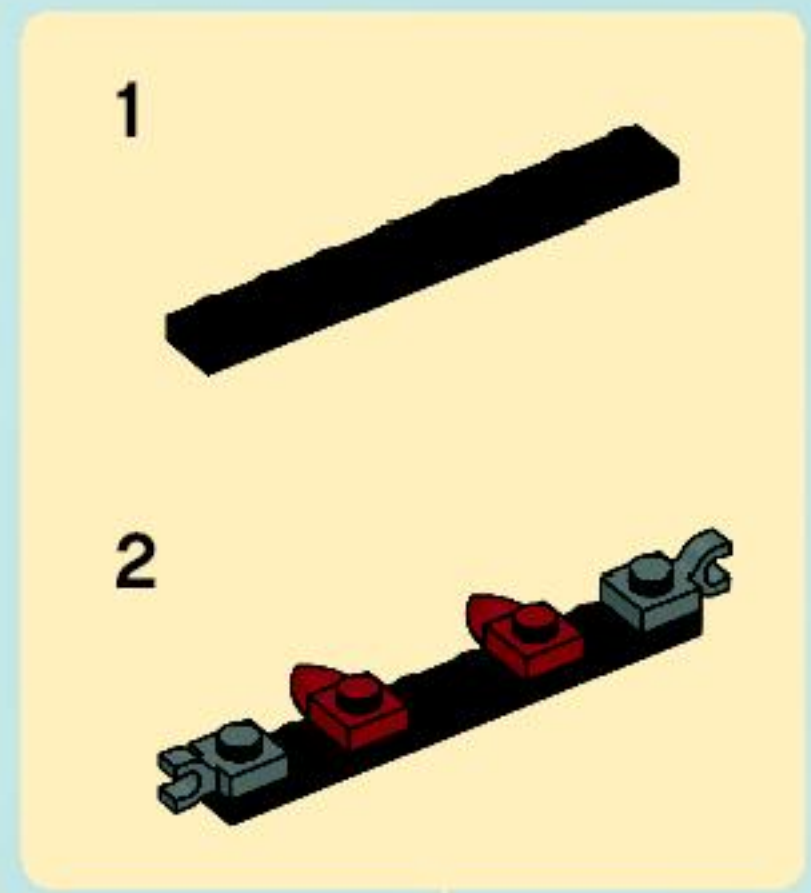





2x

42





43

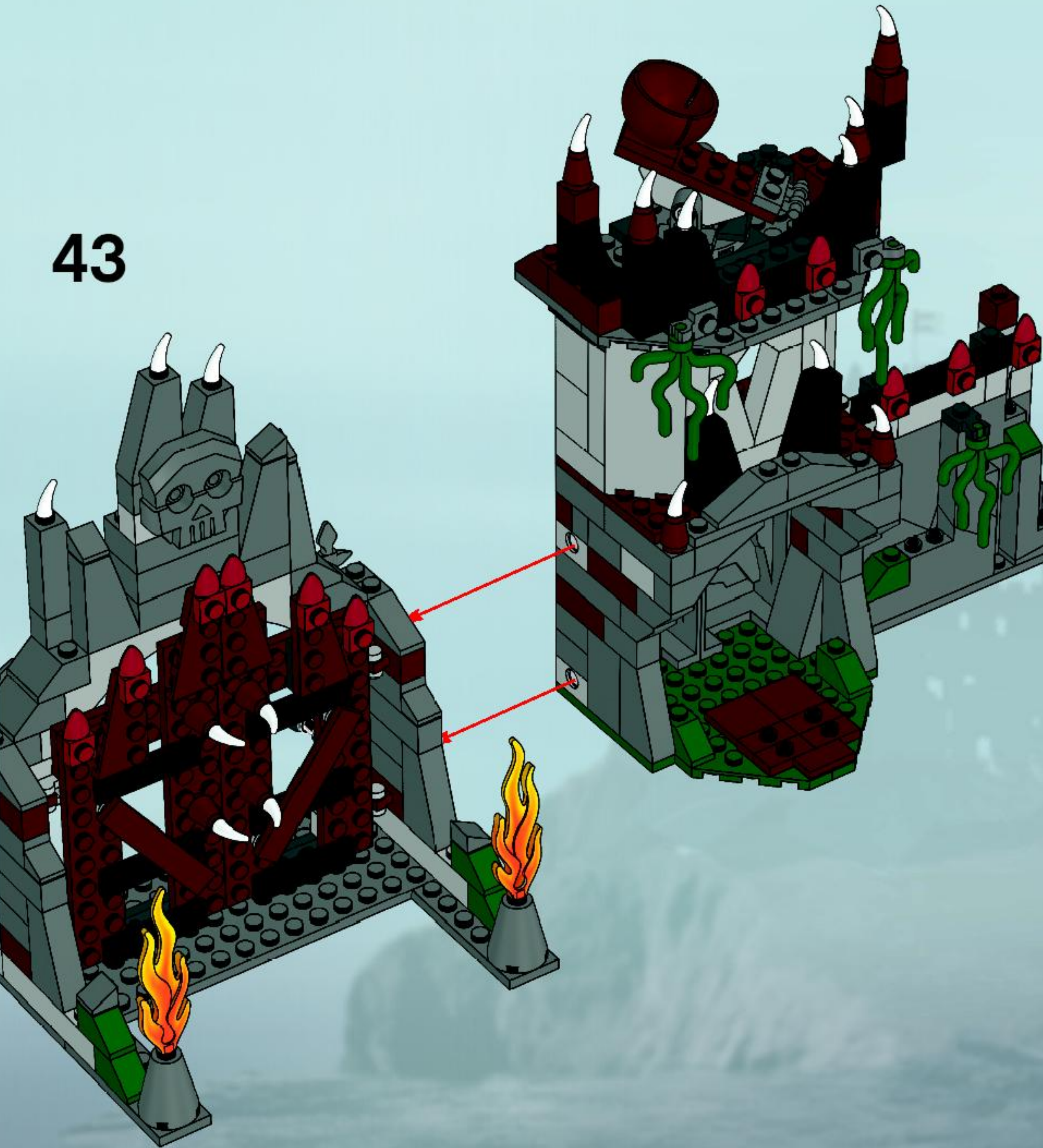



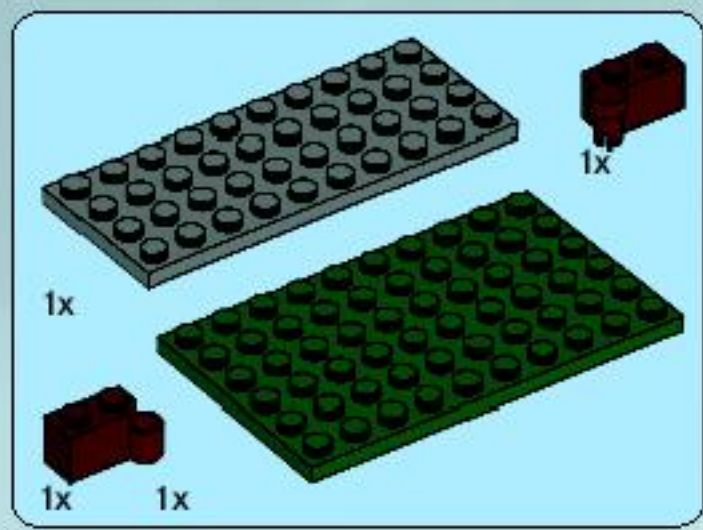
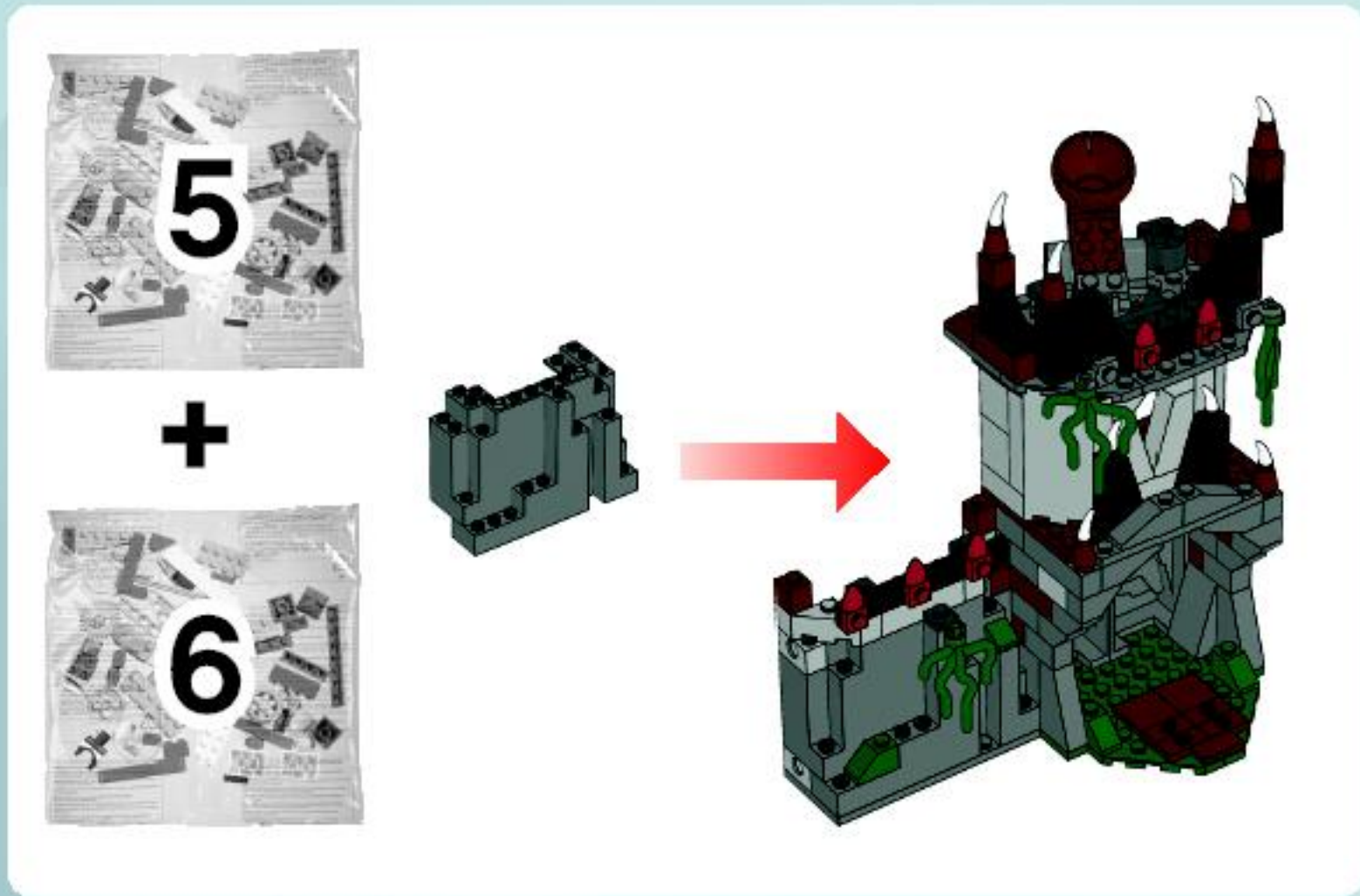

1

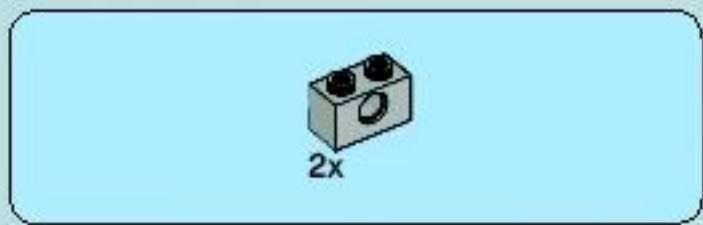
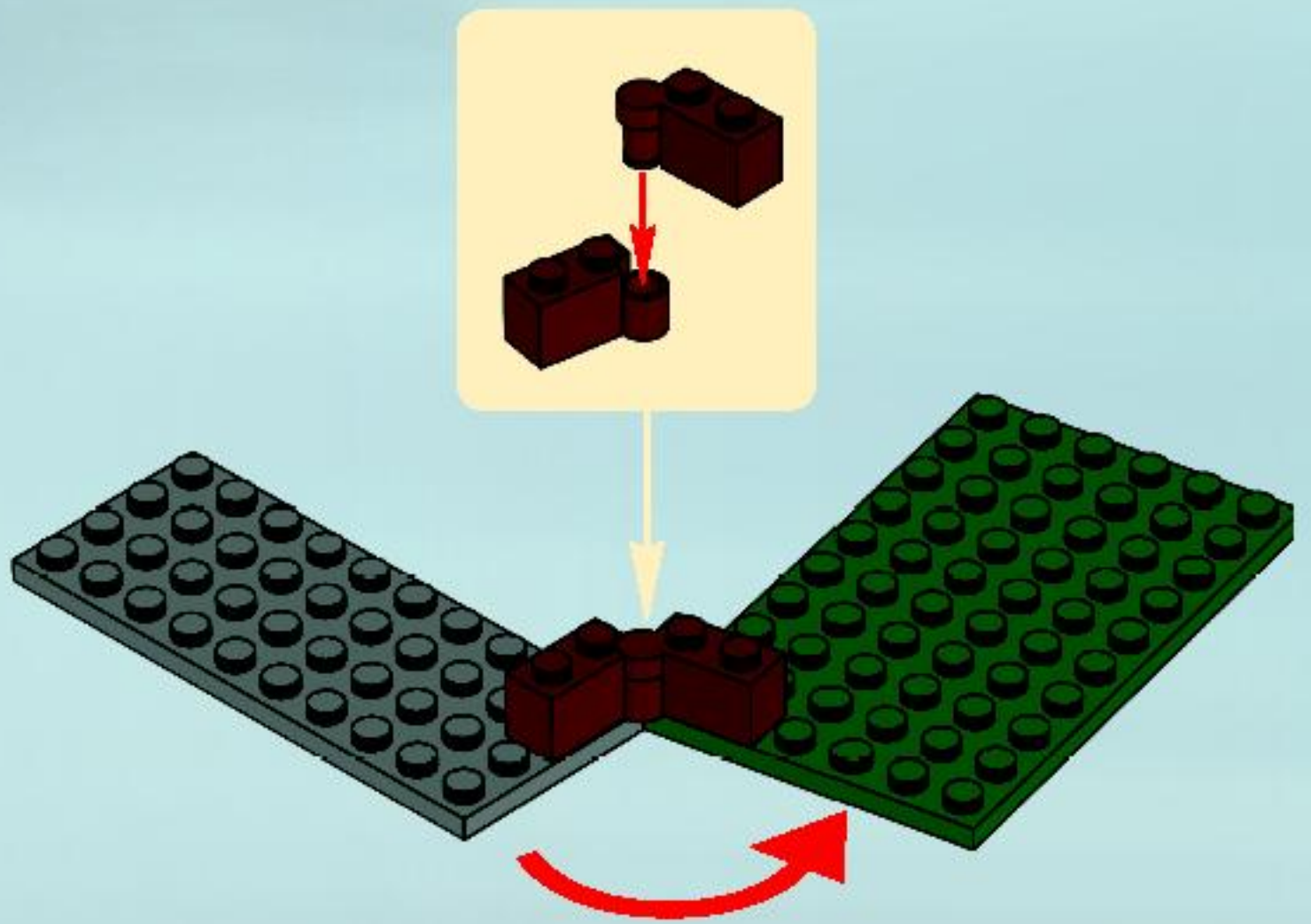

2

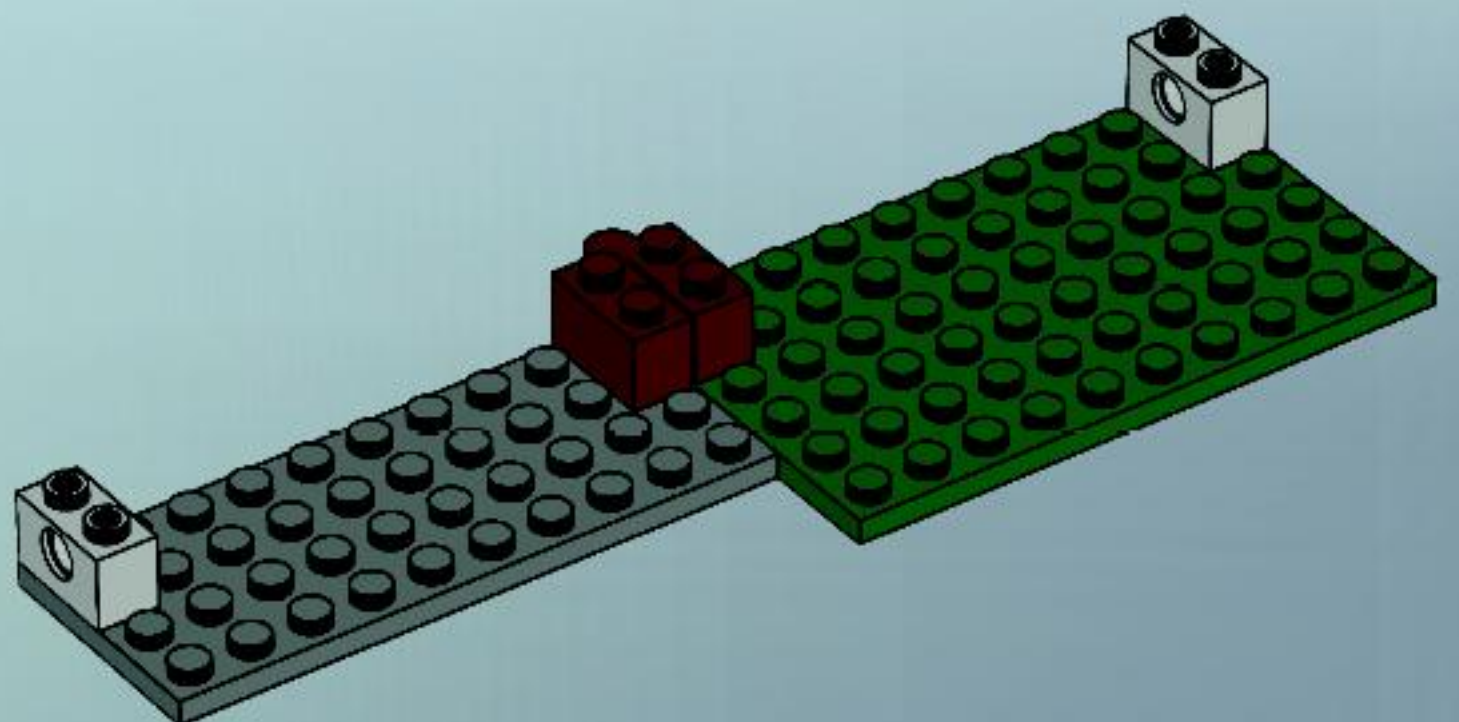



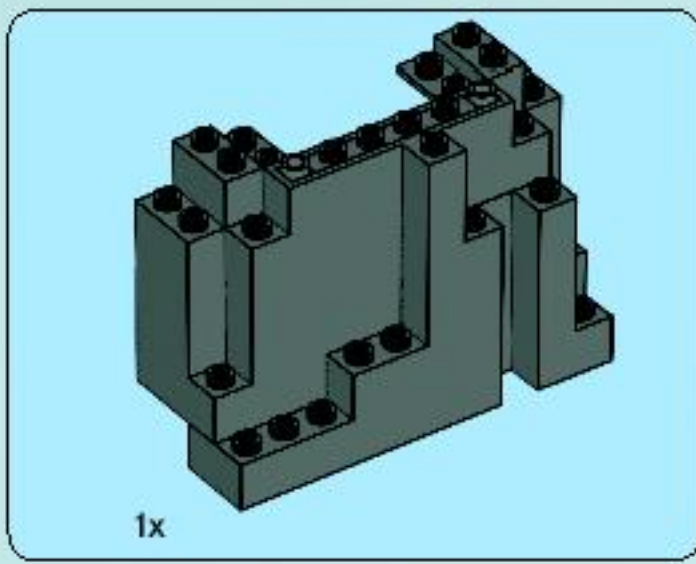

3

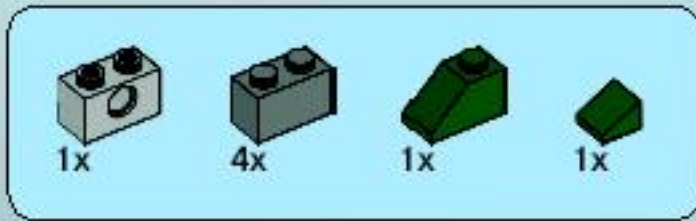
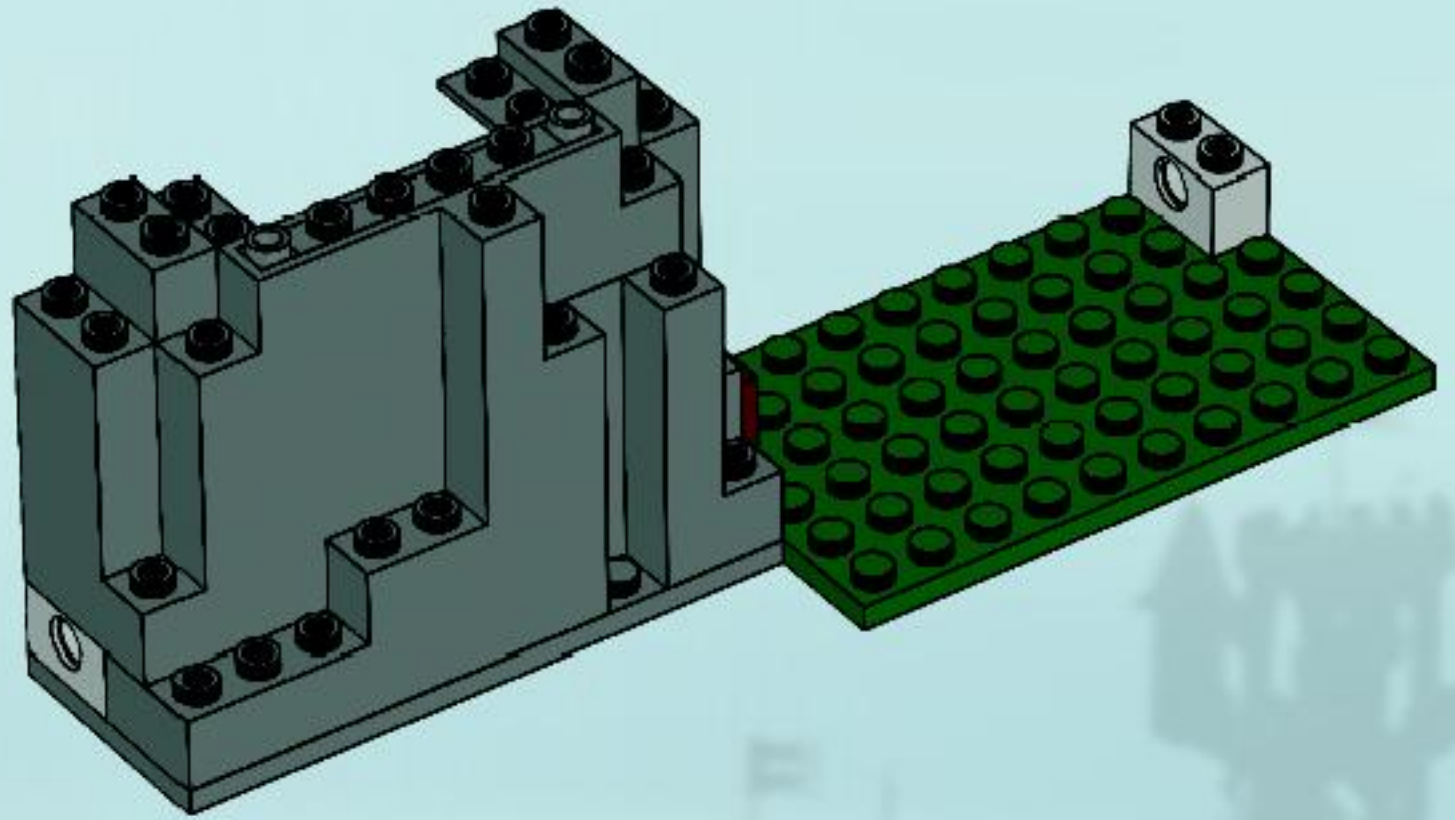

4

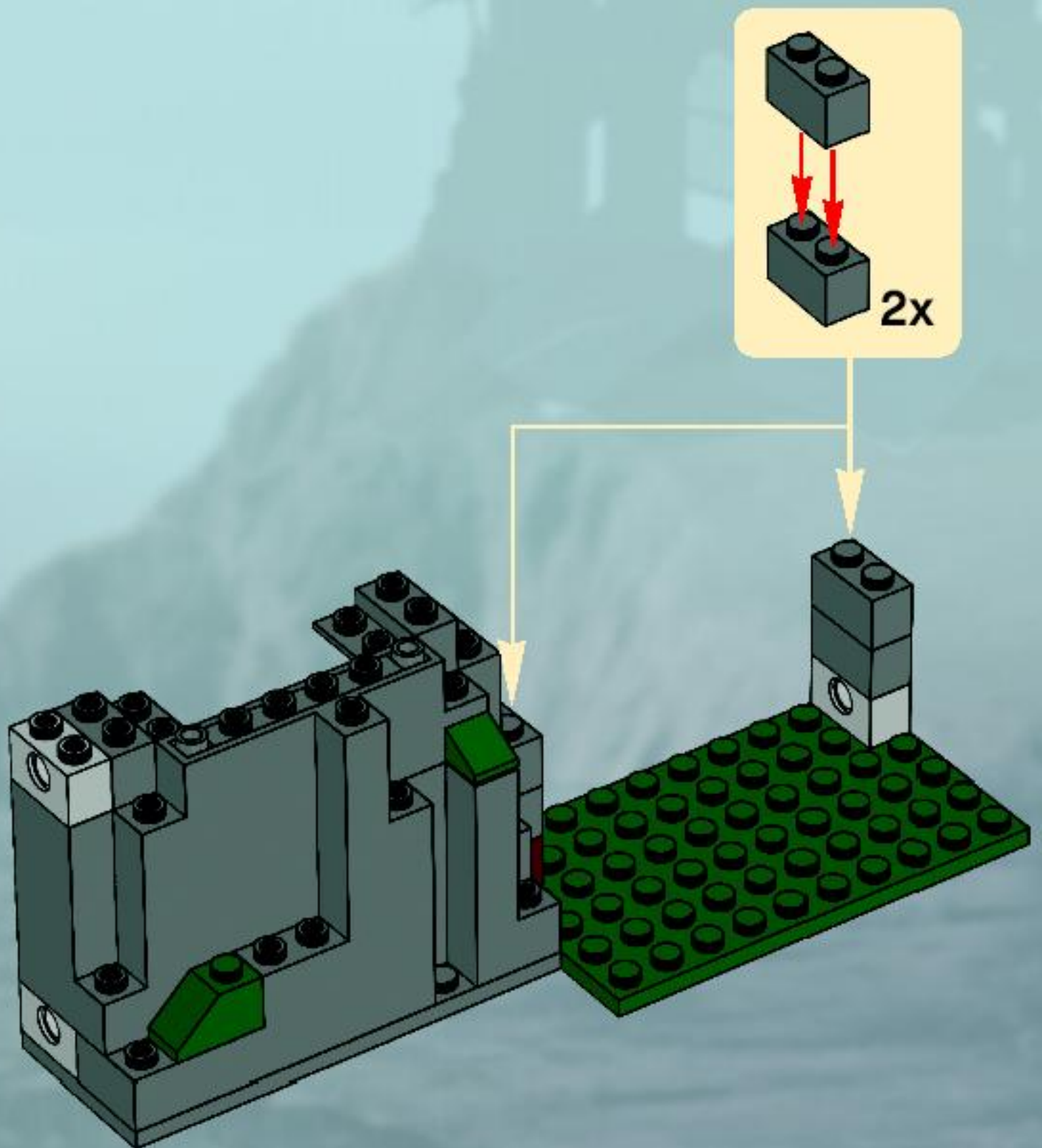



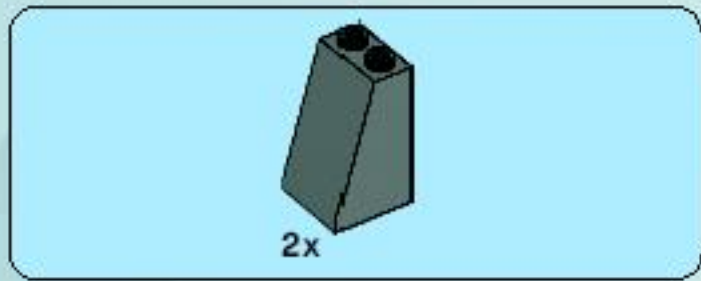

5

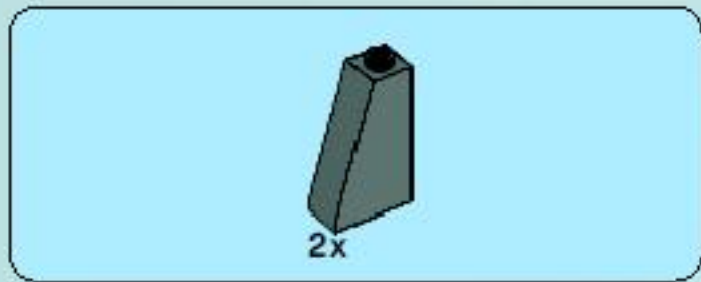
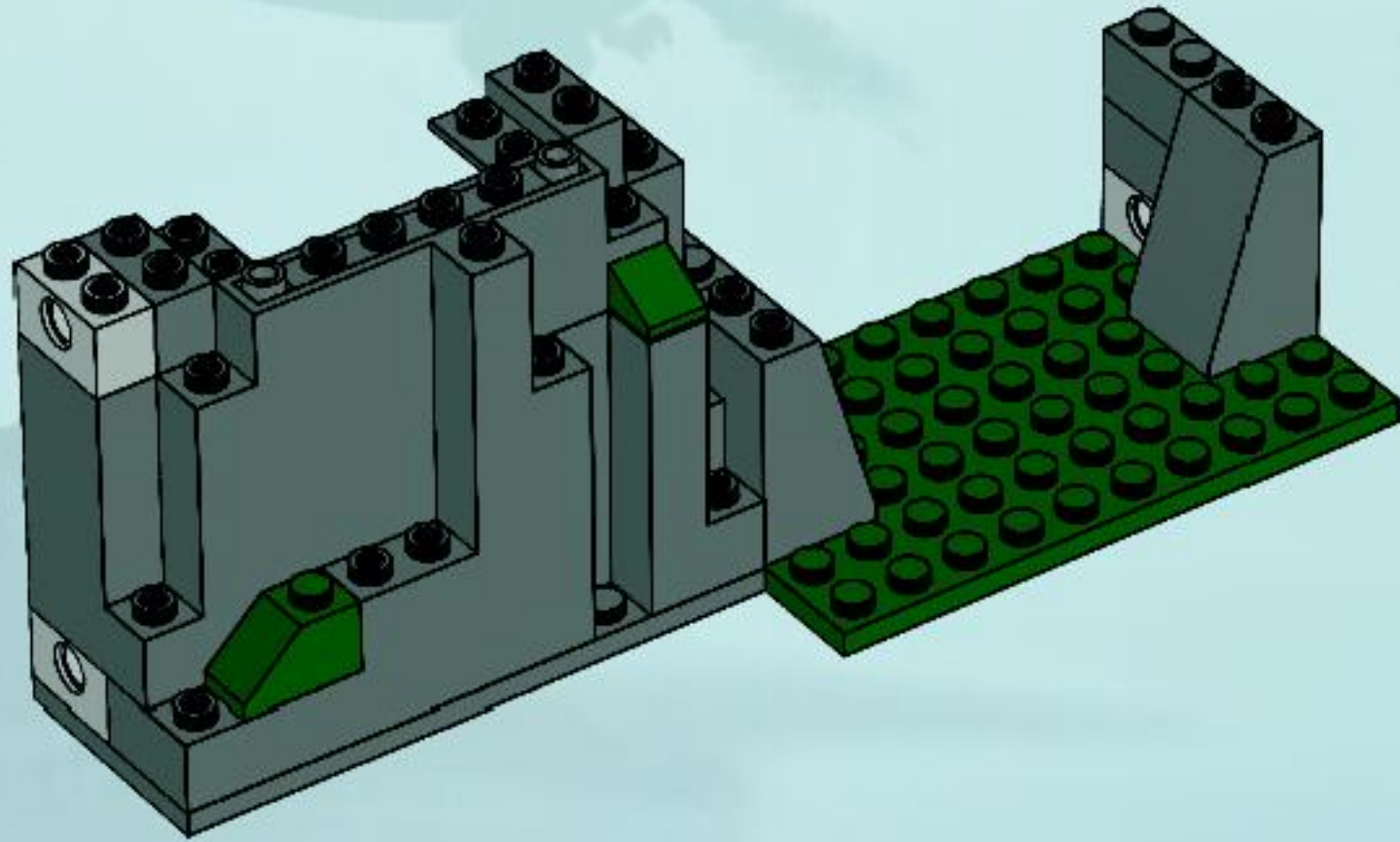

6

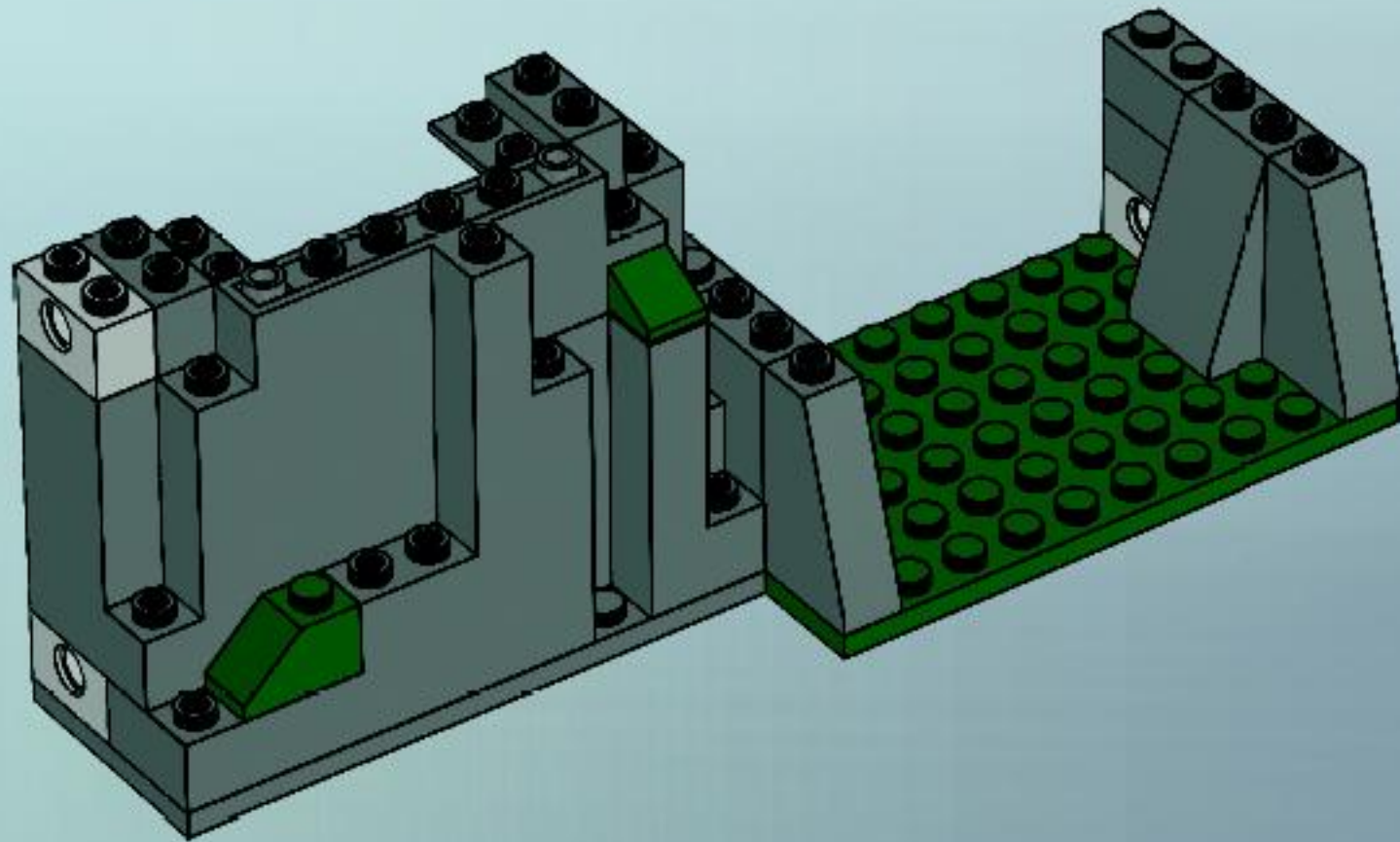



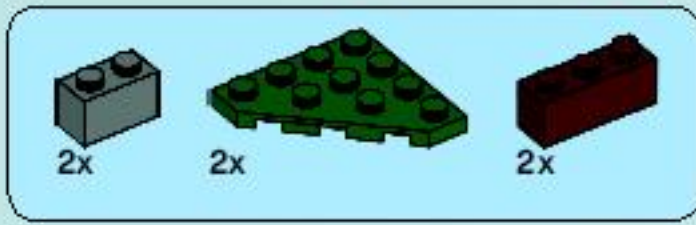

7

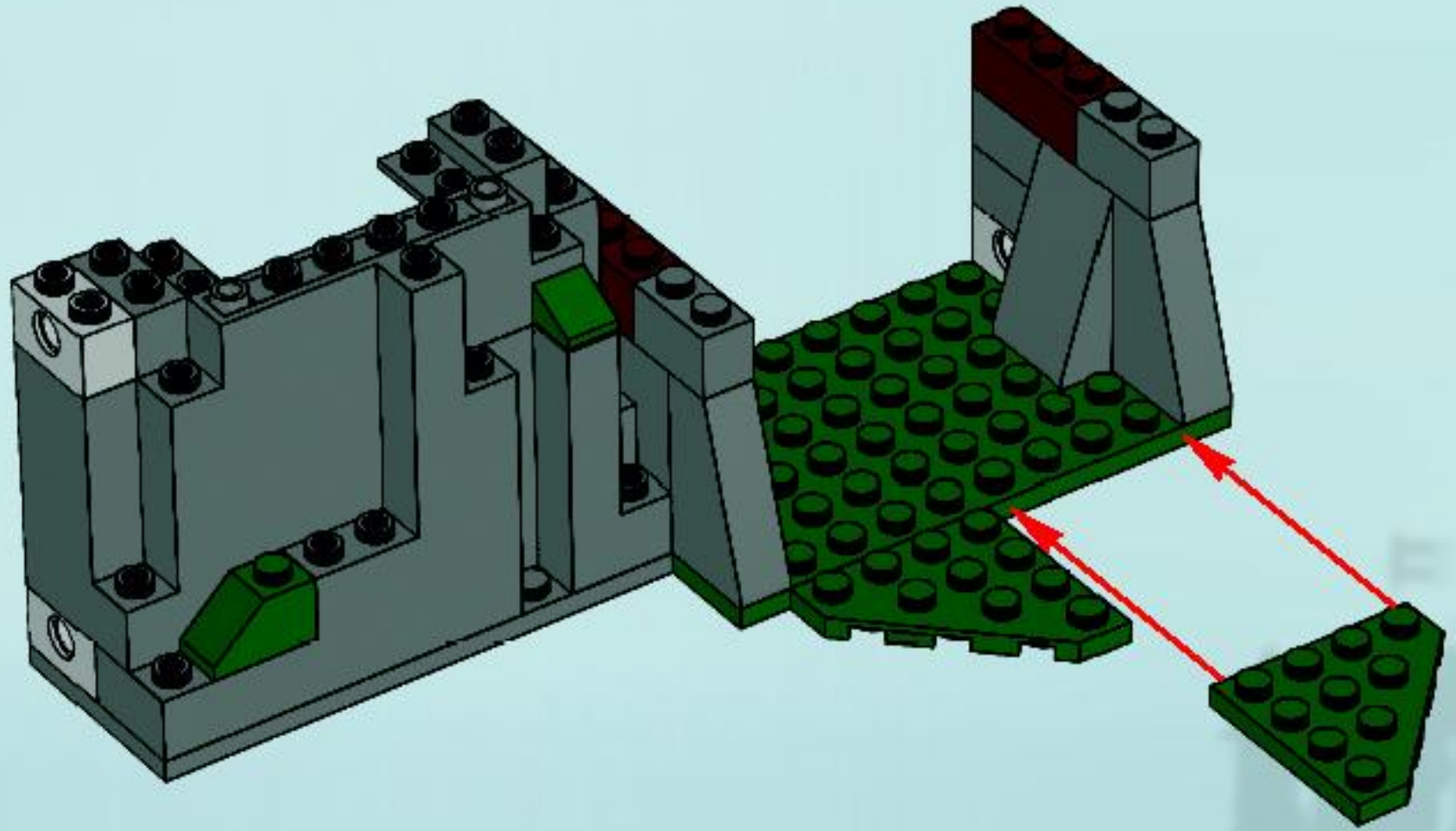

8

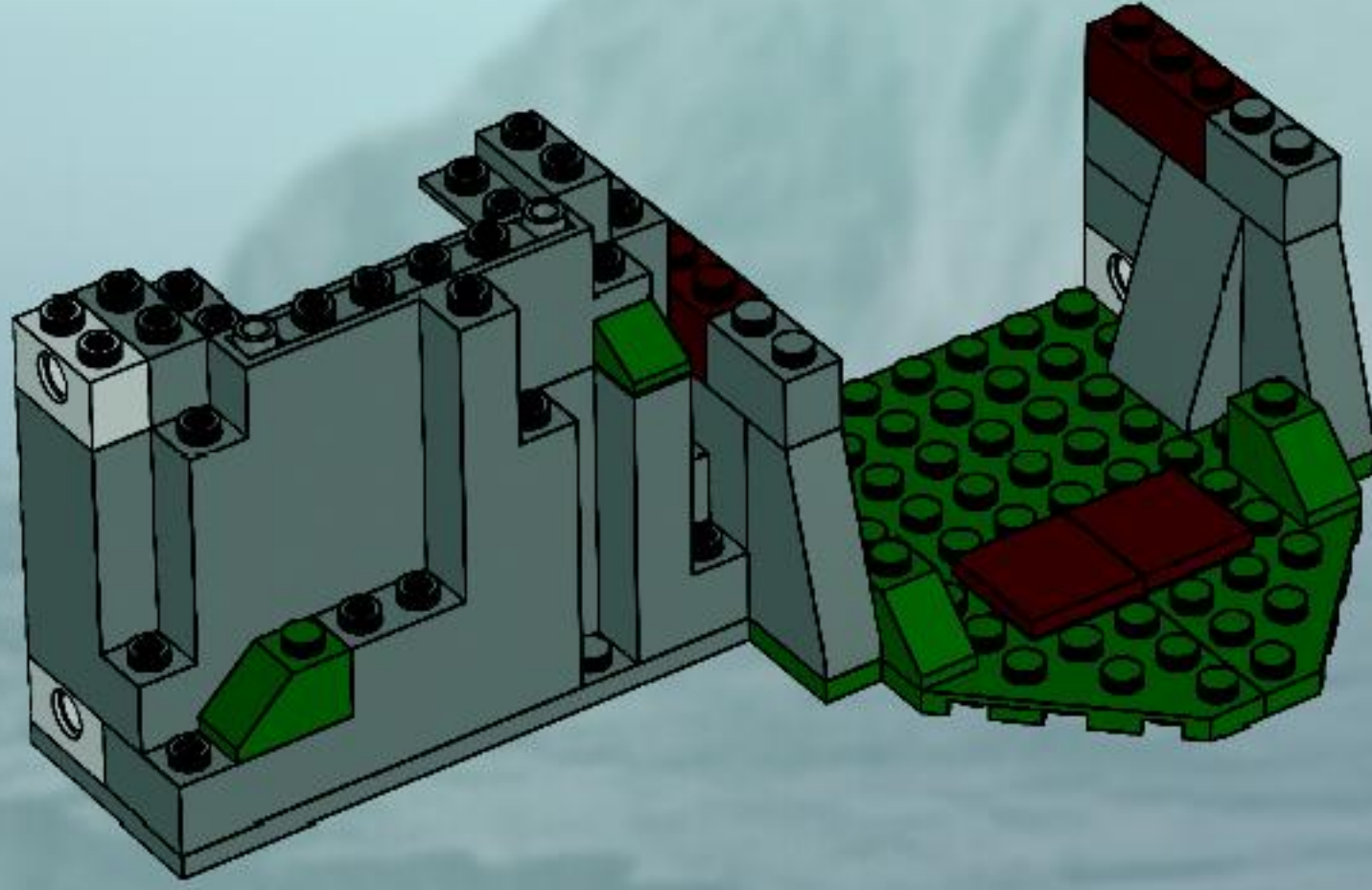





9

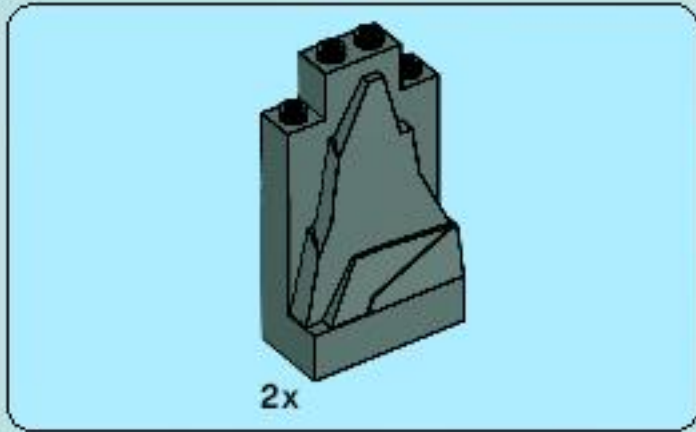
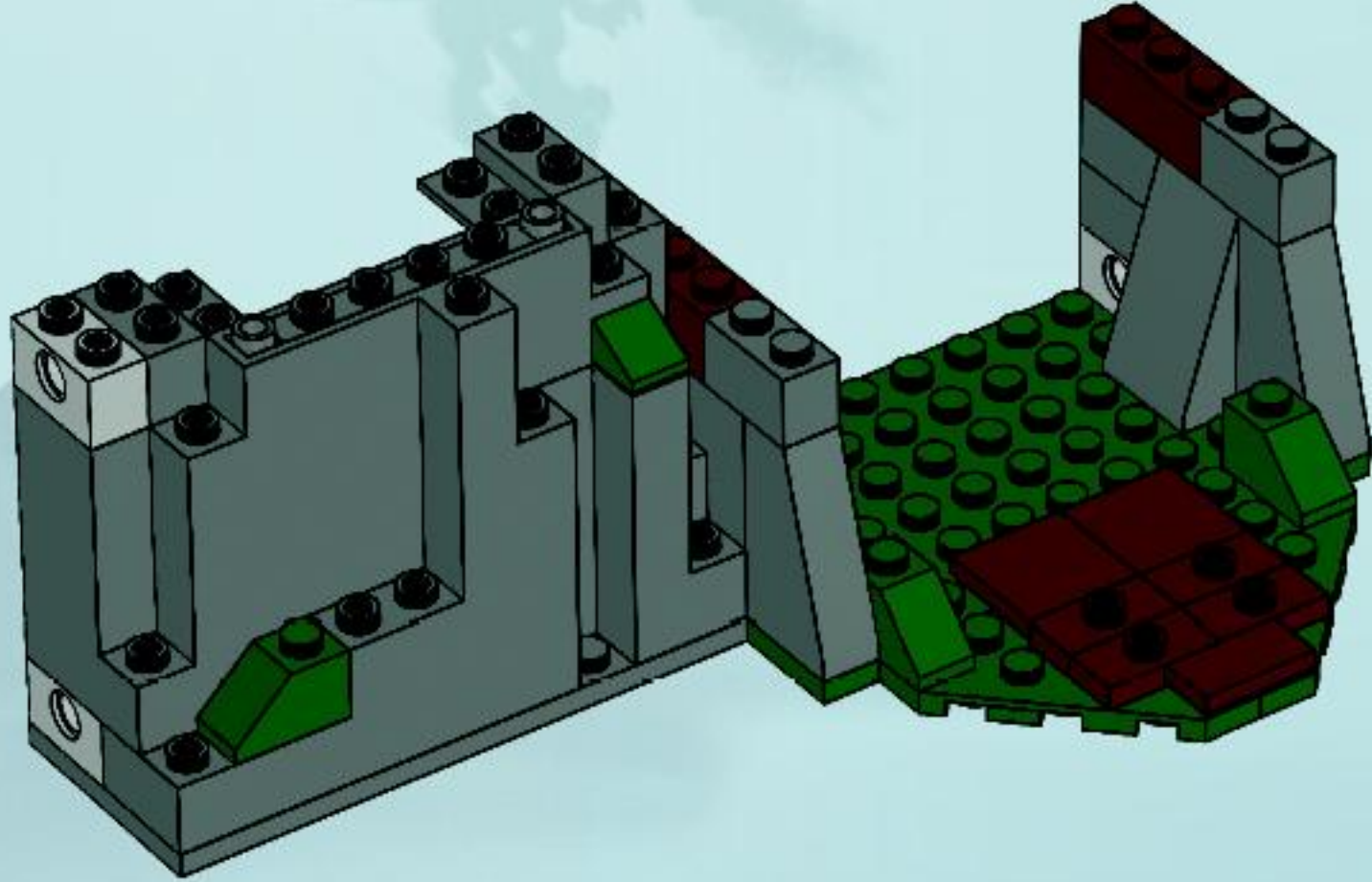

10

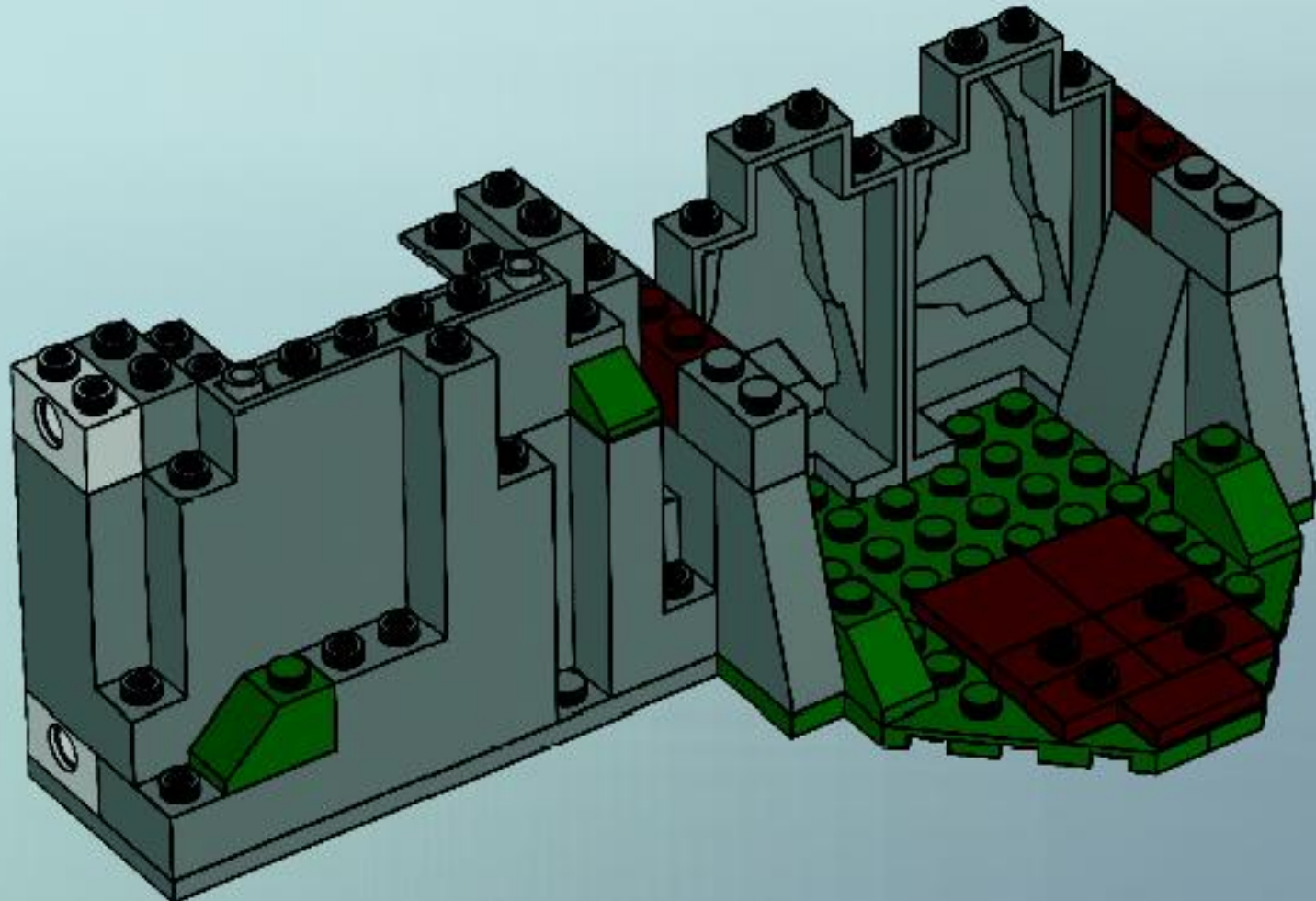



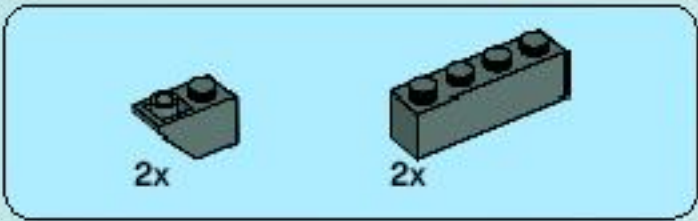

# 11

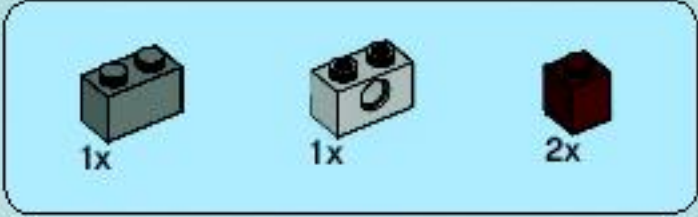
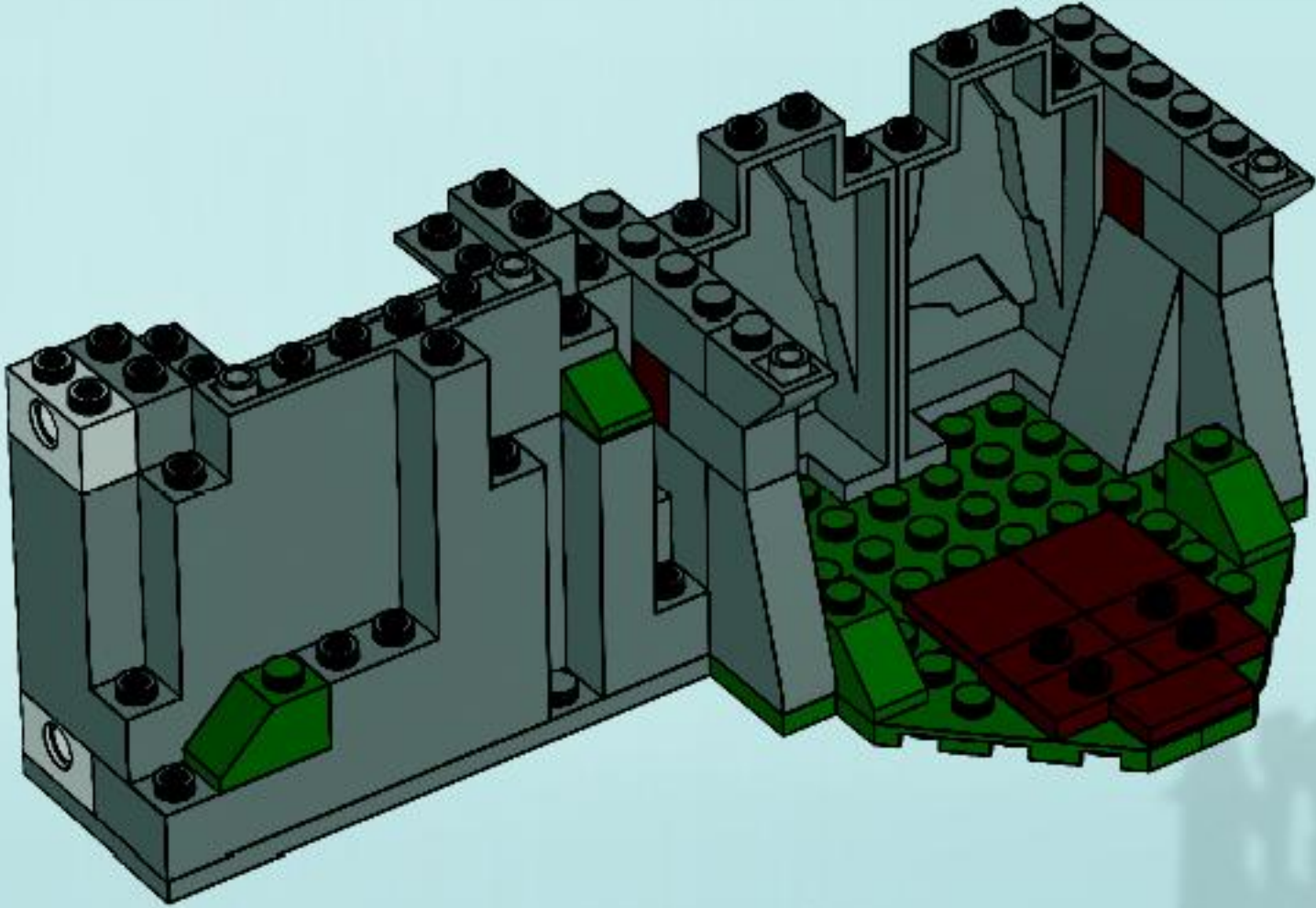

# 12

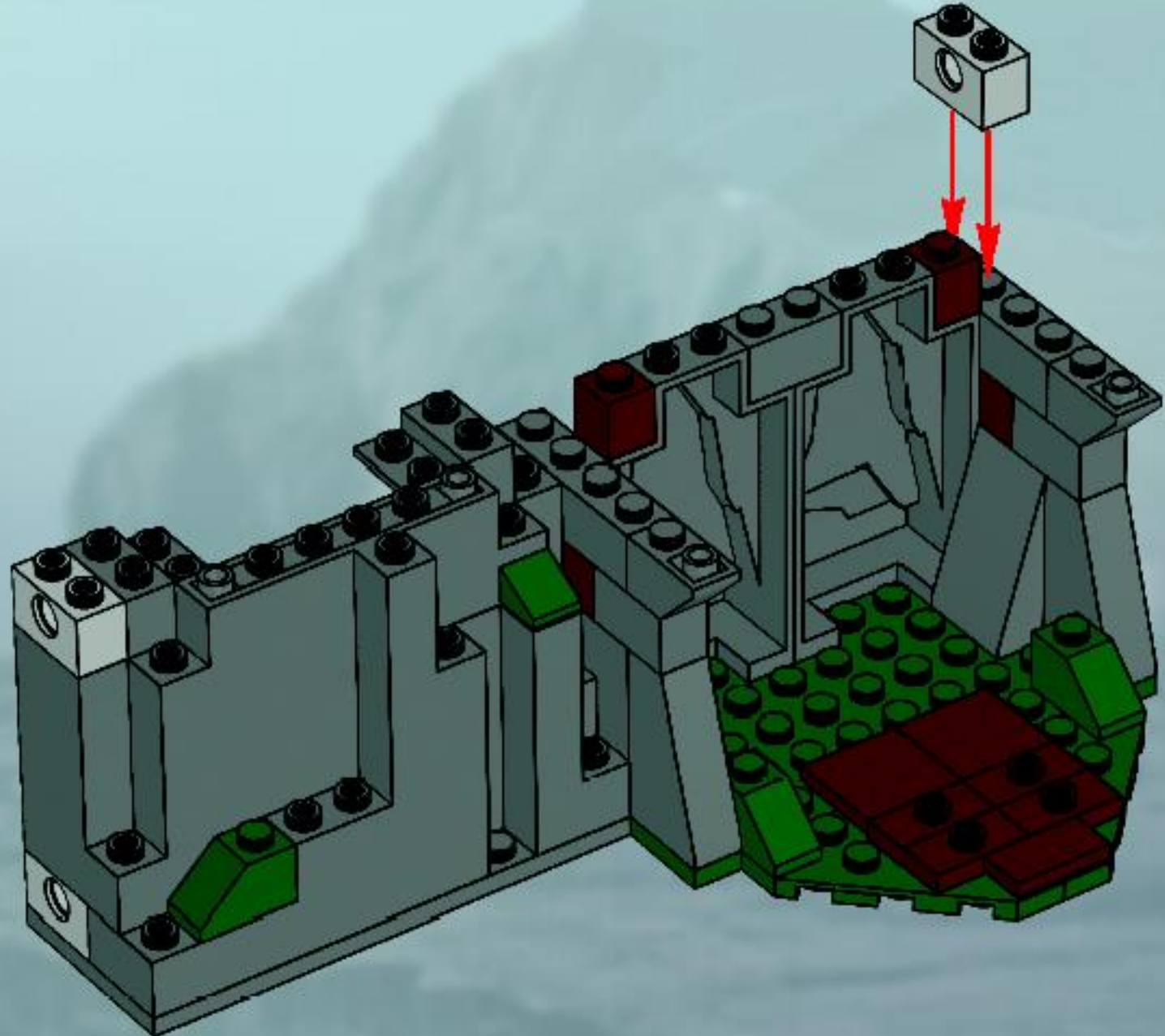



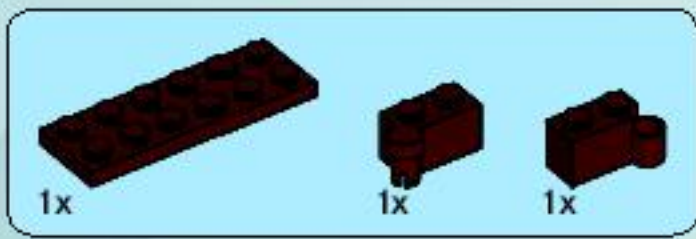

13

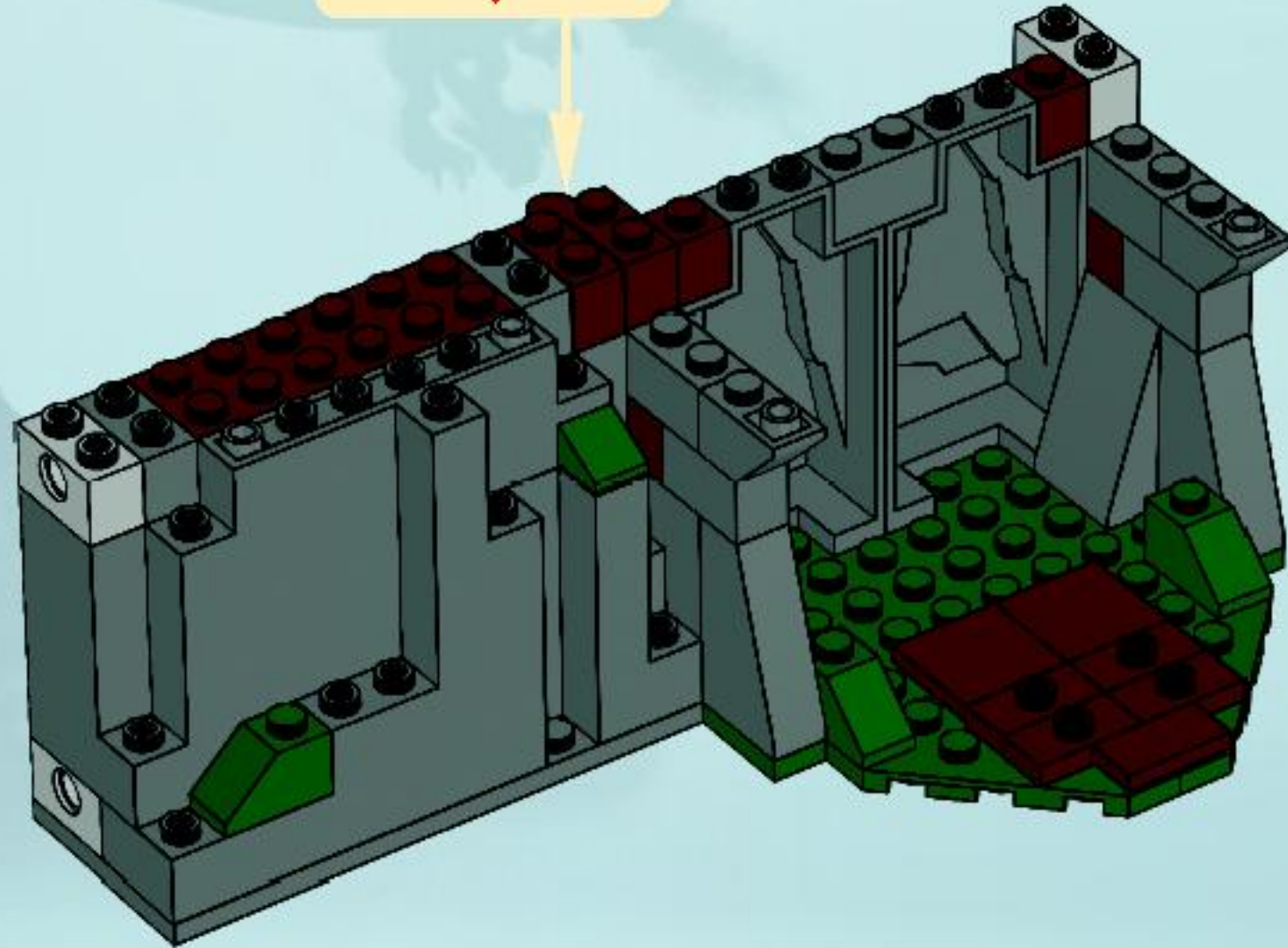

14

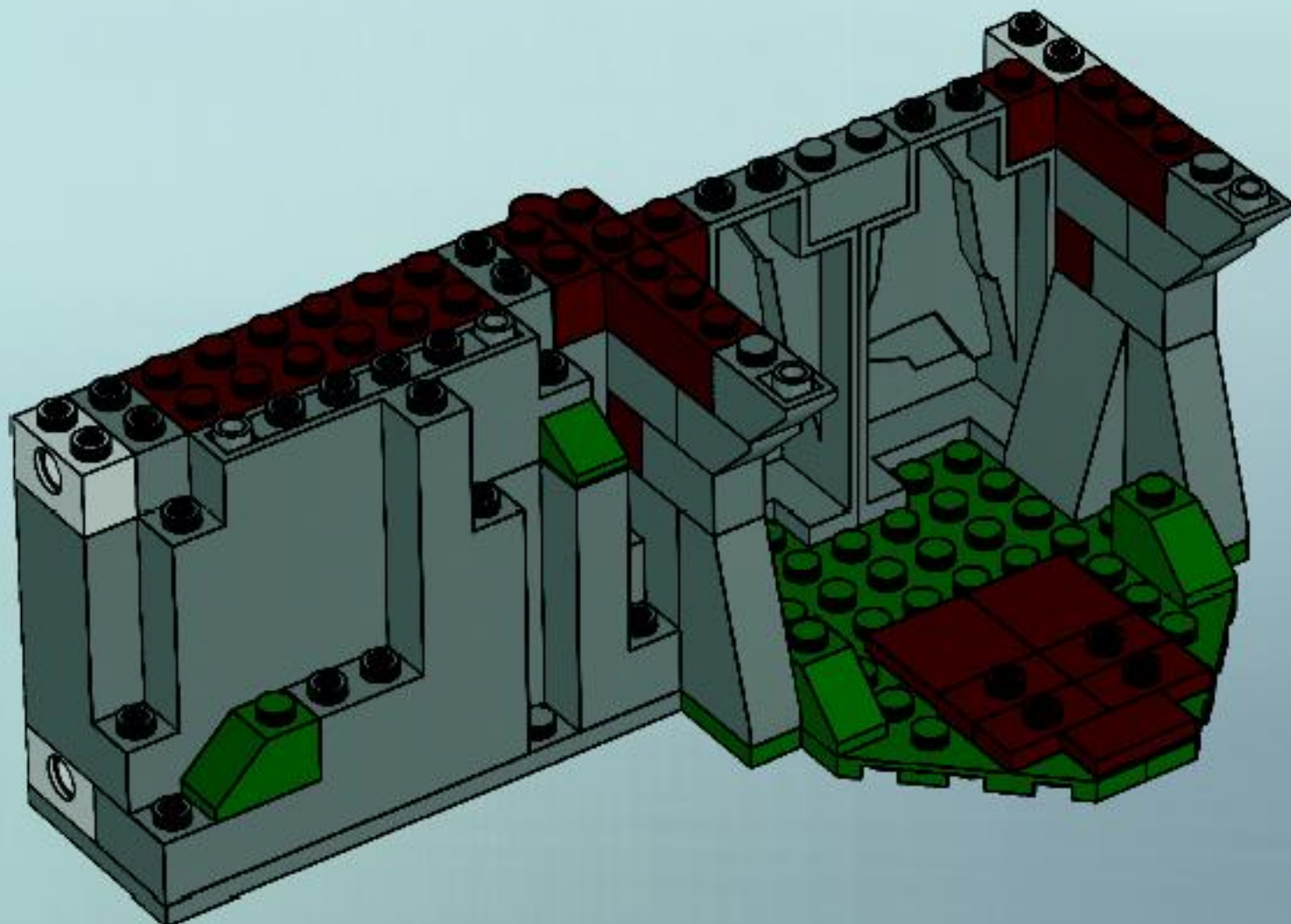



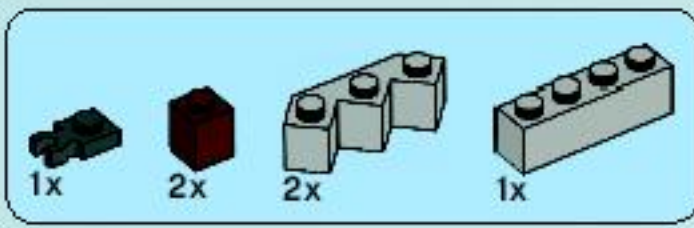

15

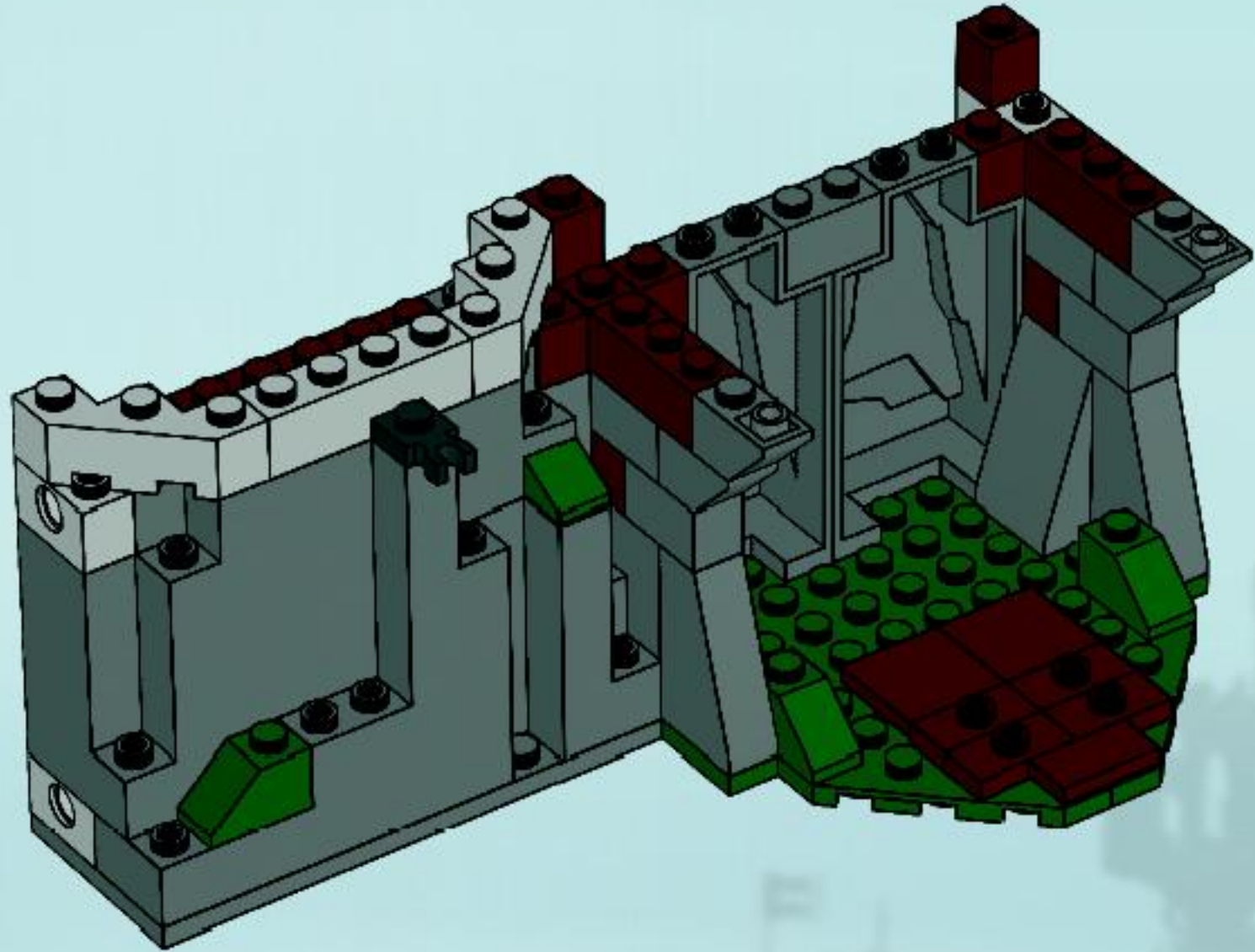

16

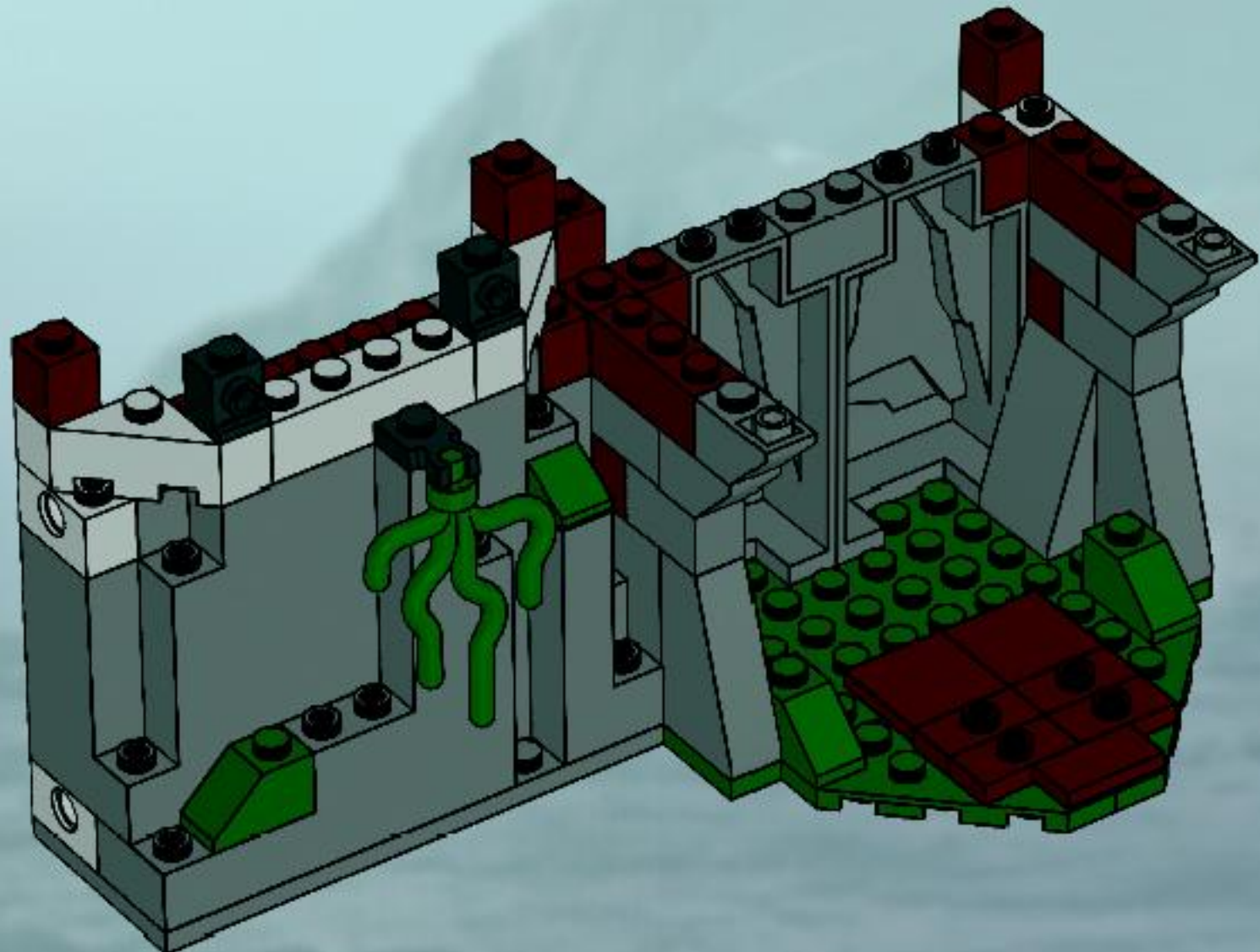





17

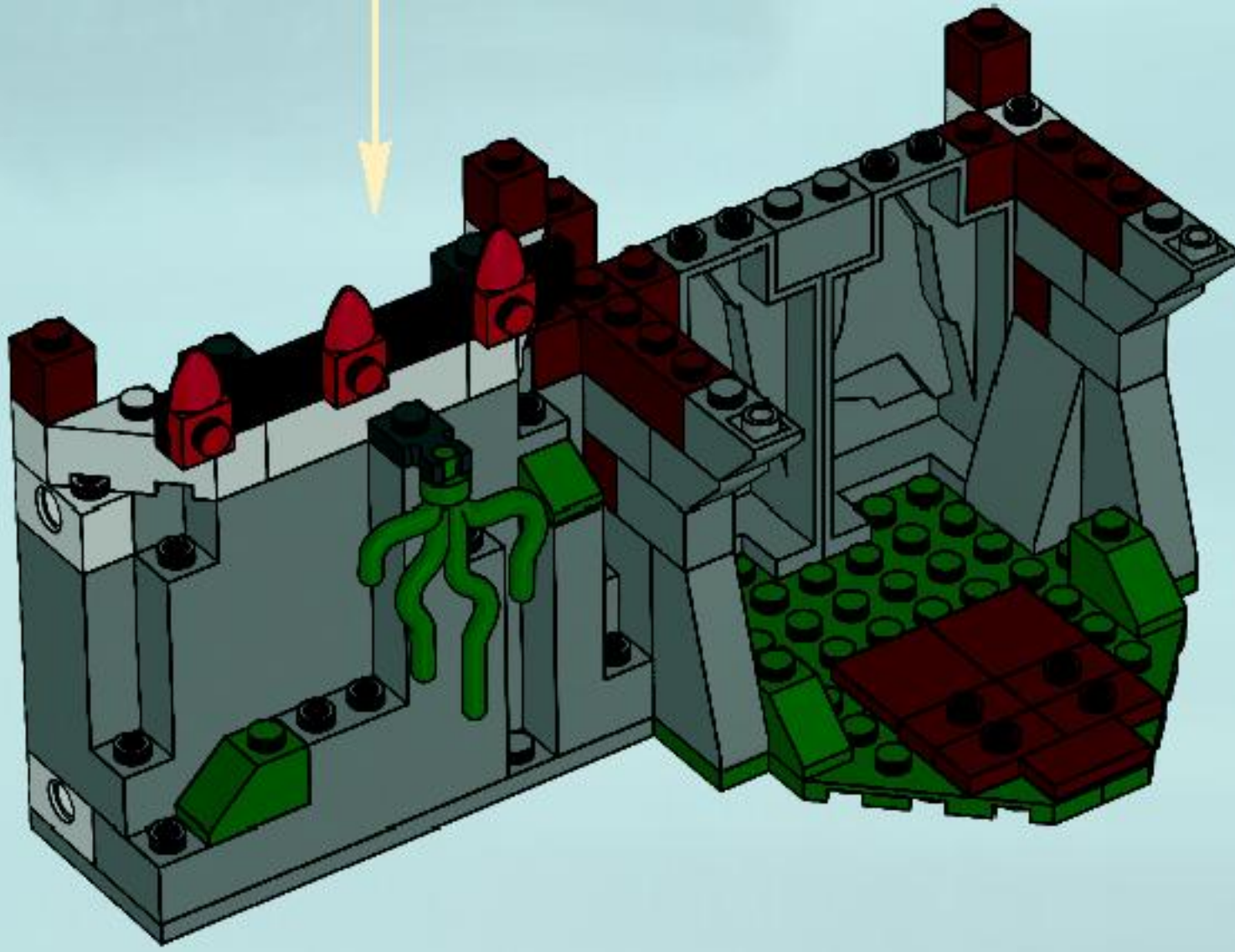
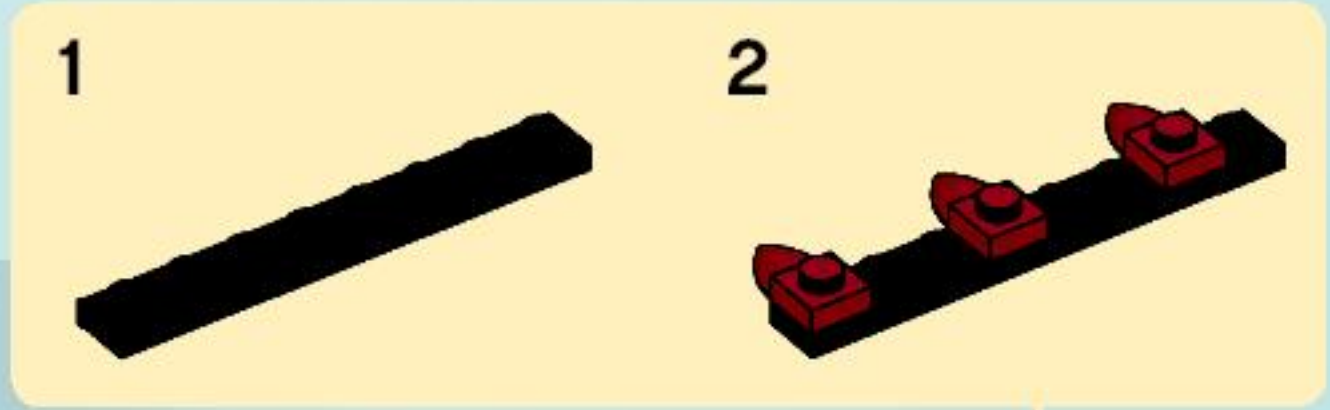



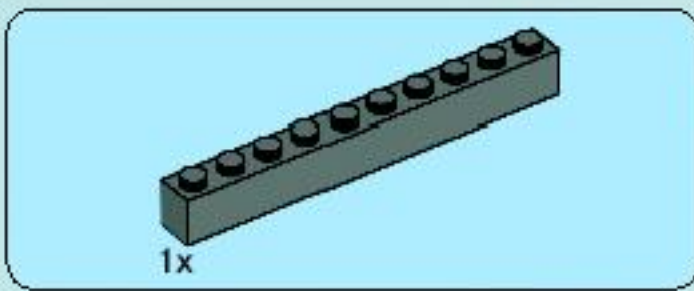

18

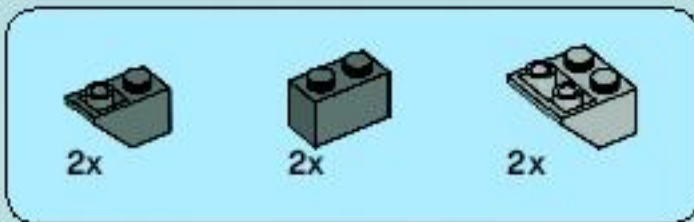
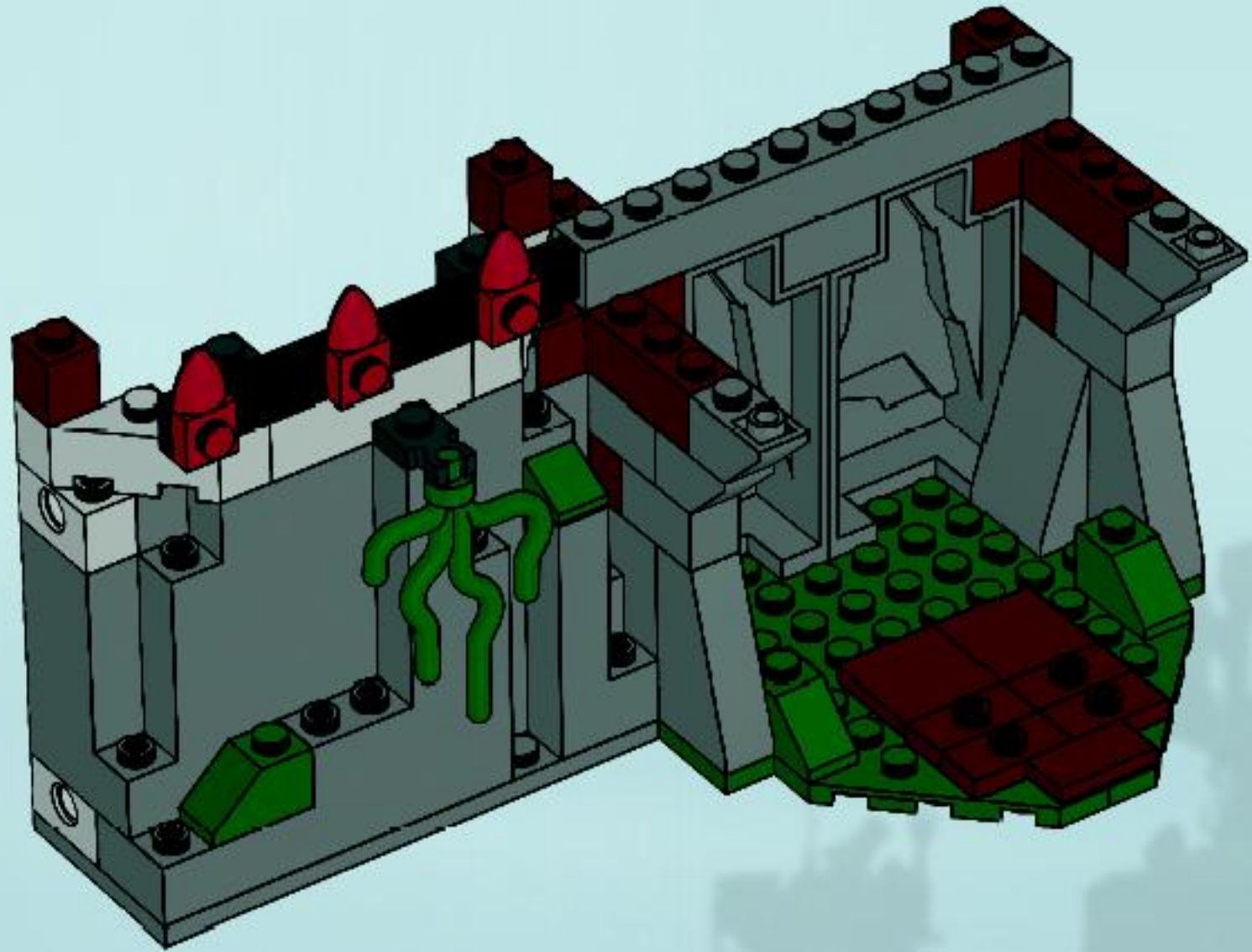

19

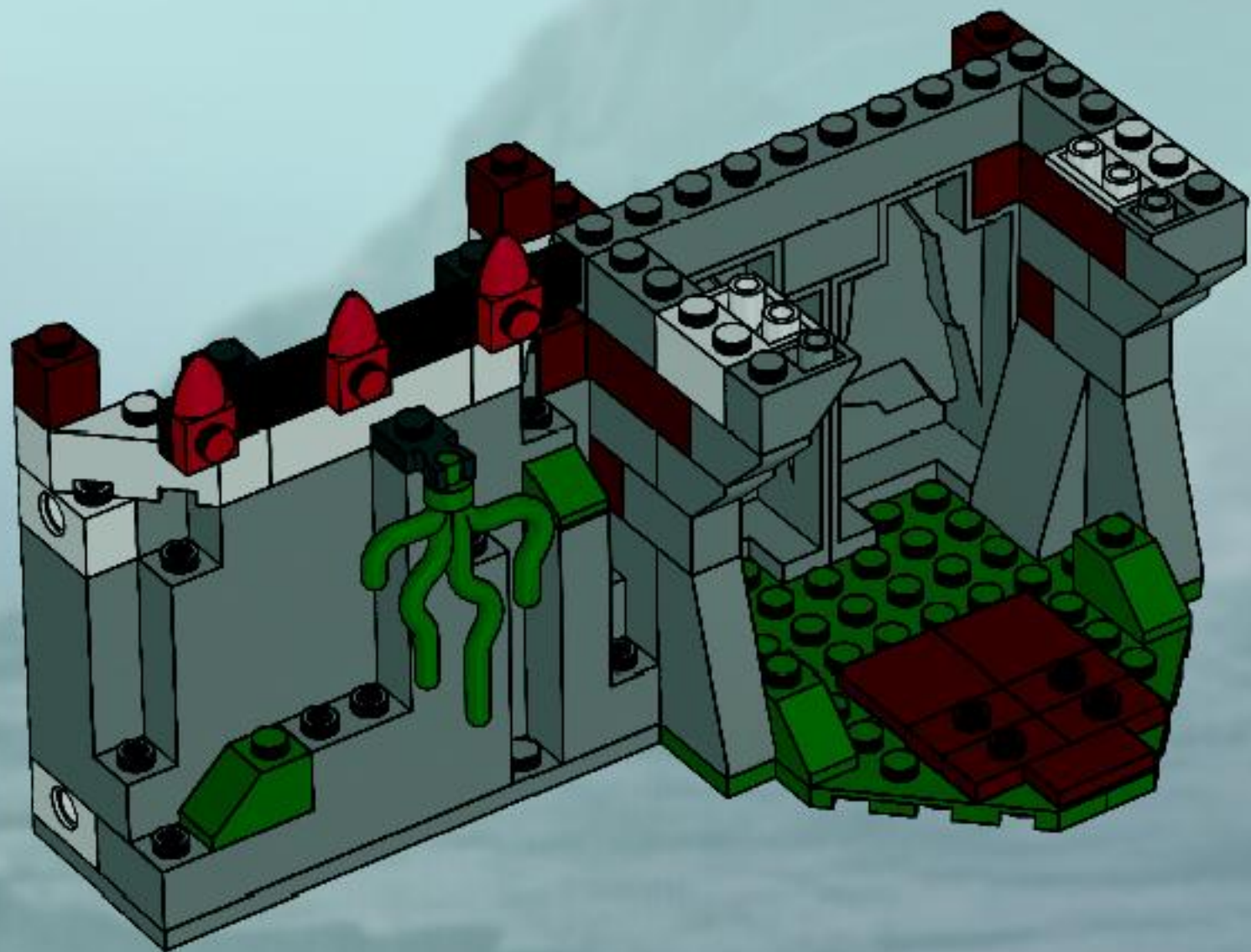



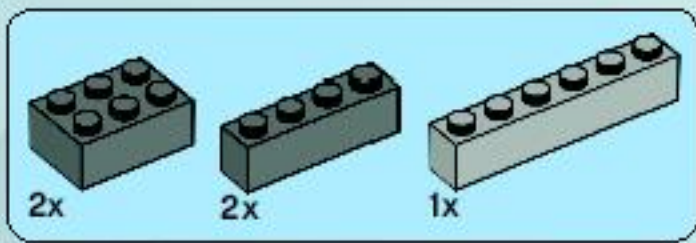

20

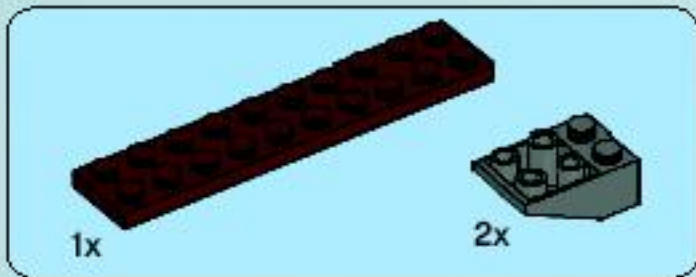
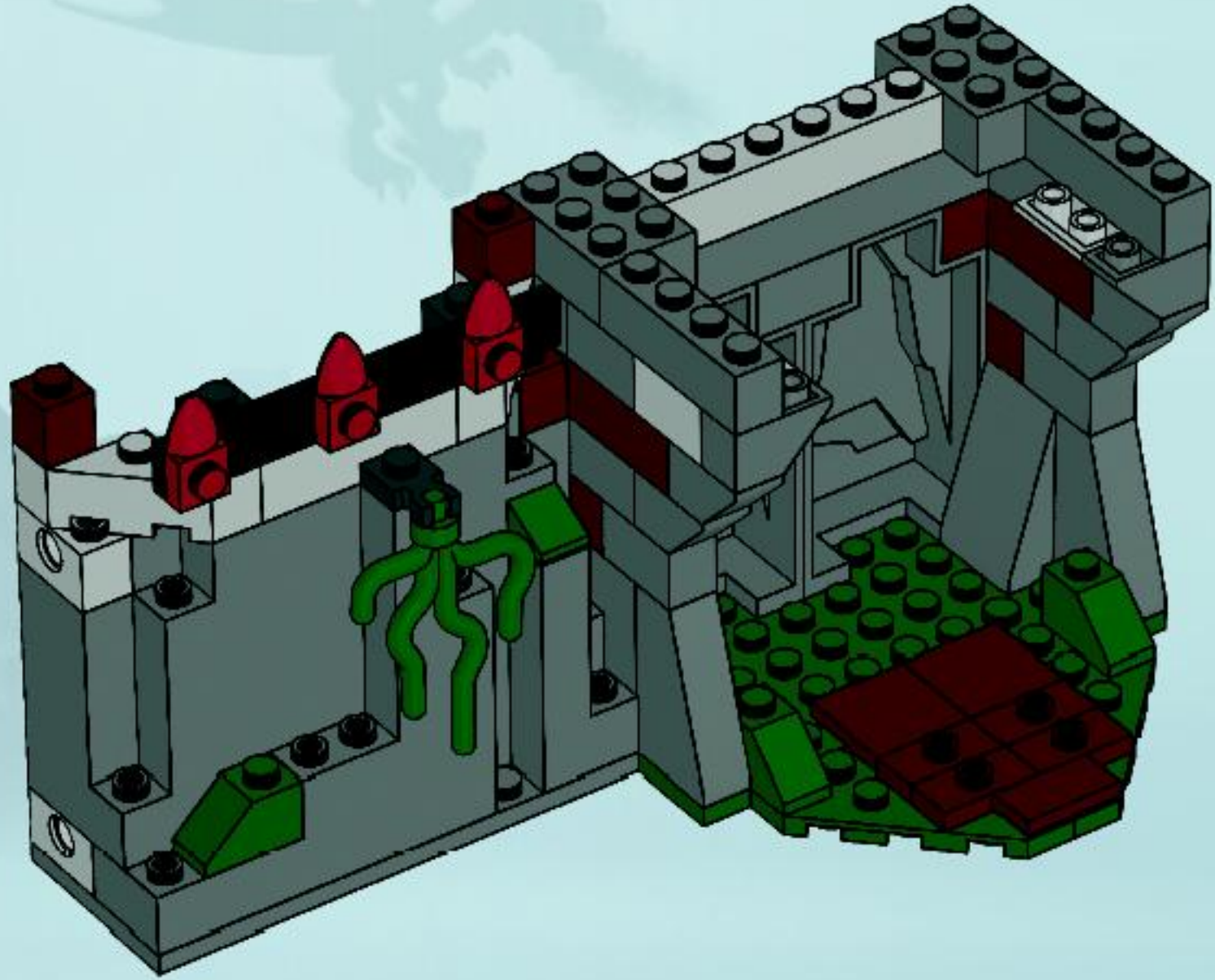

21

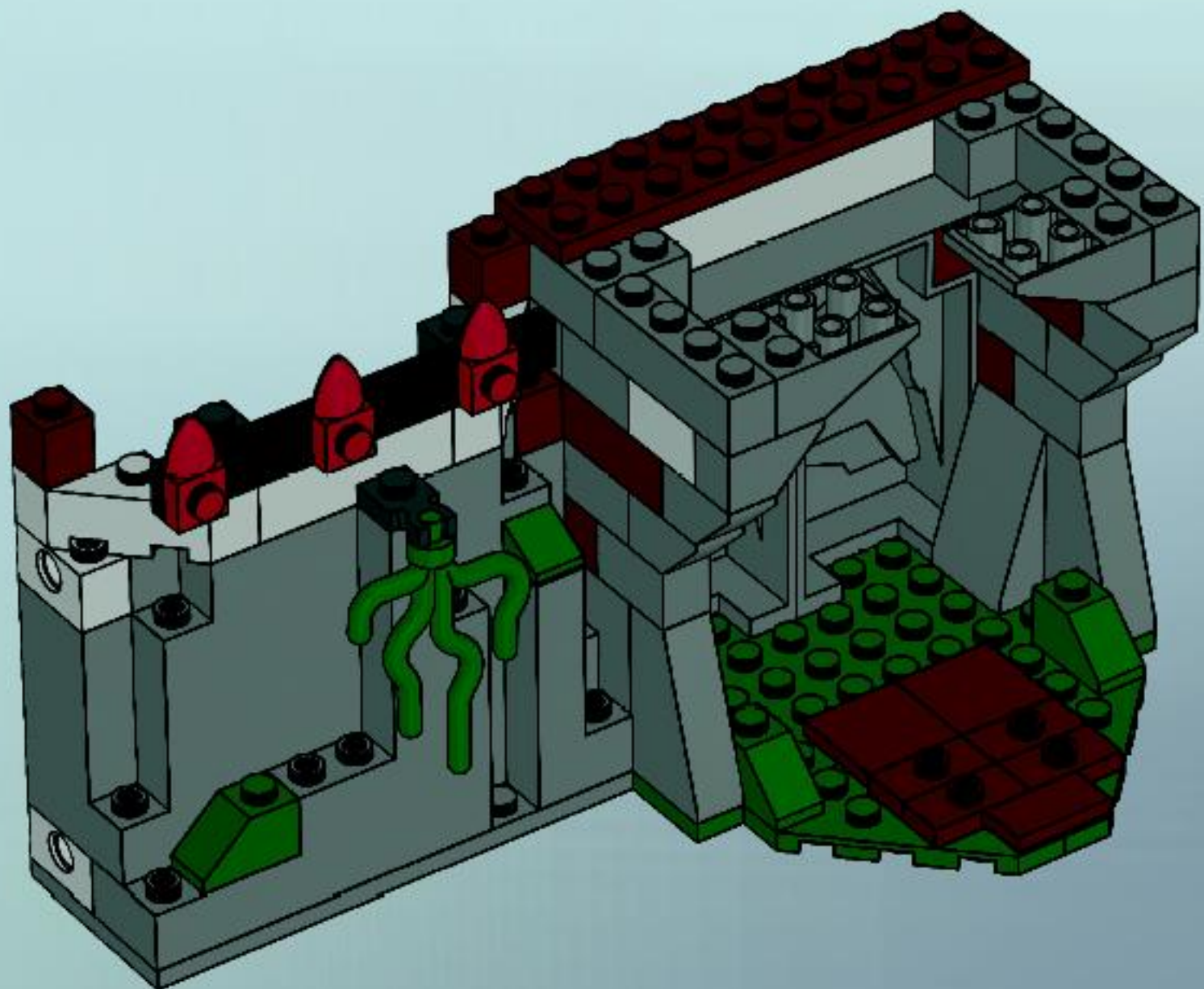



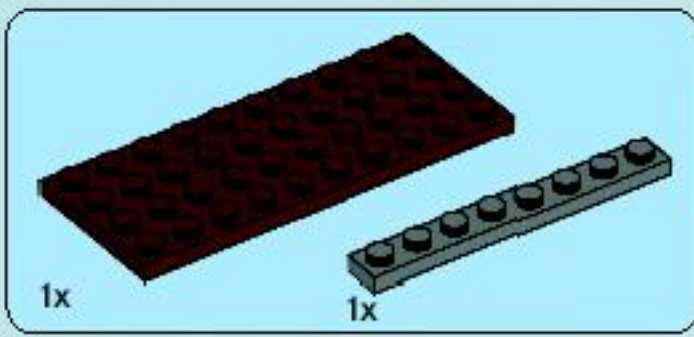

22

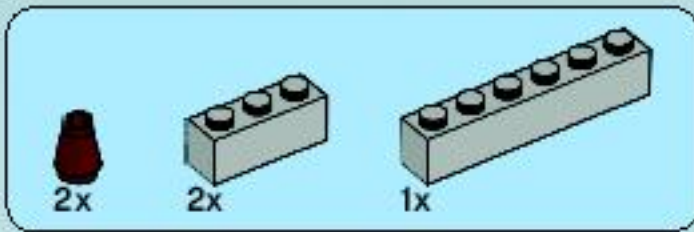
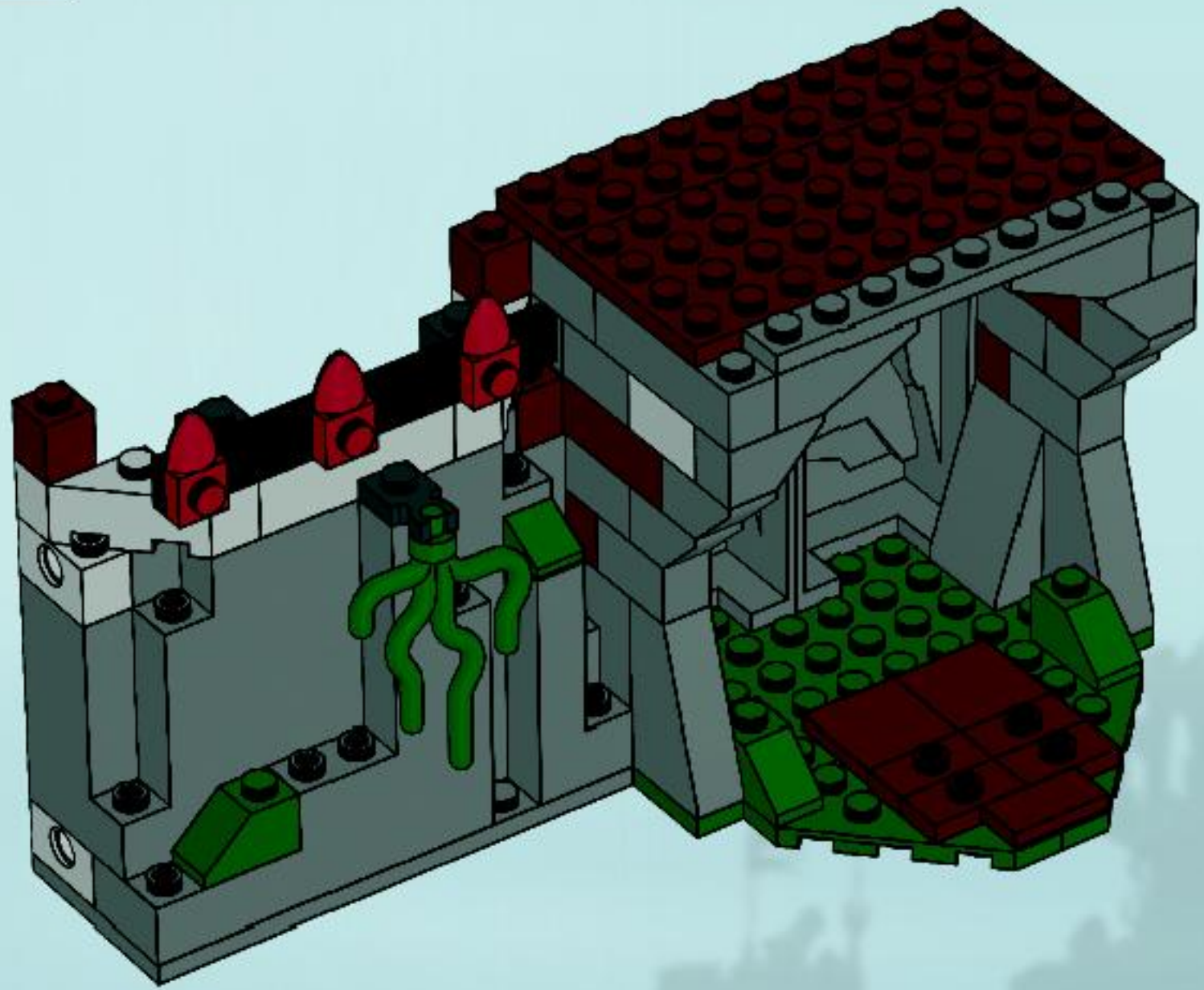

23

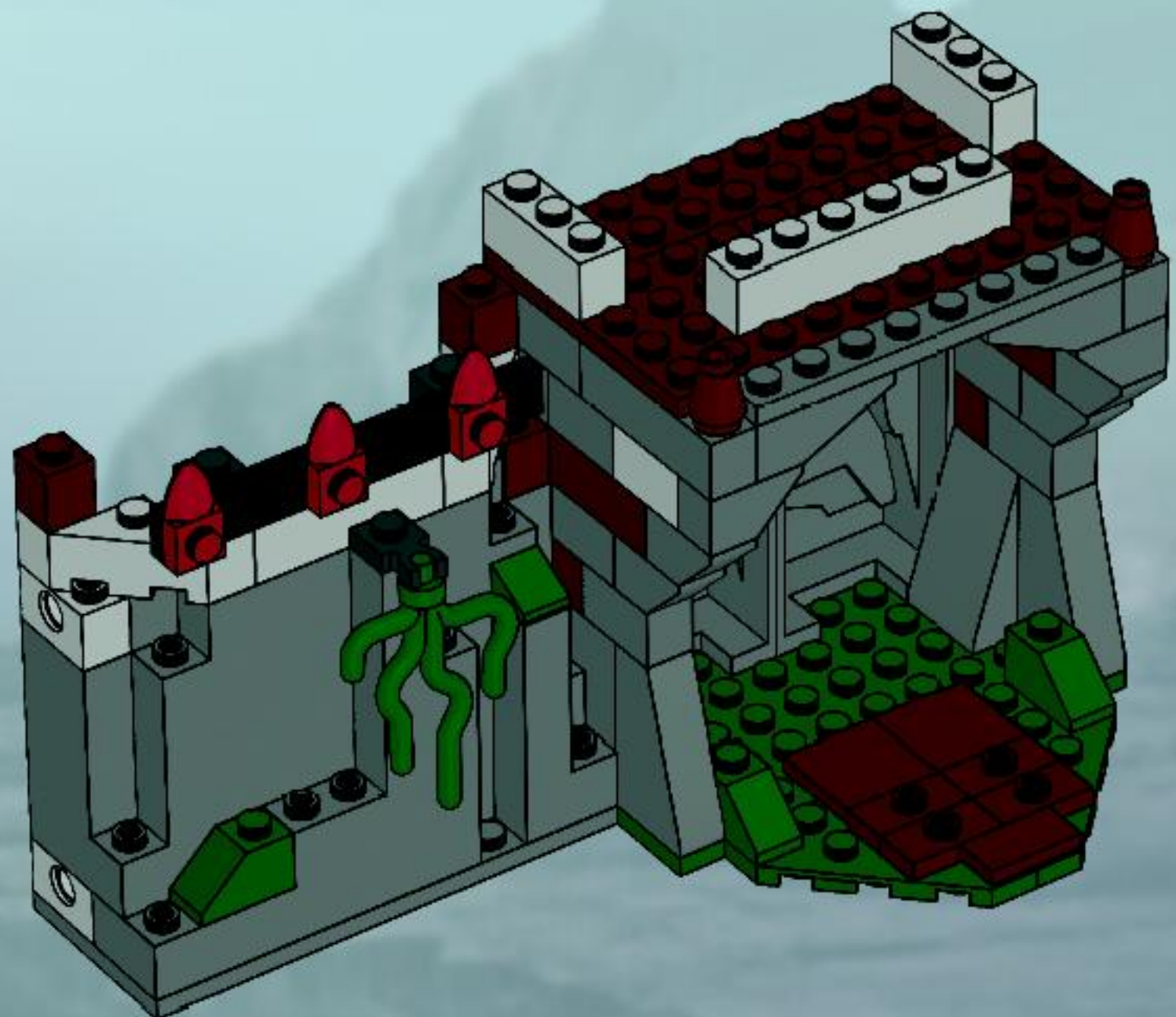



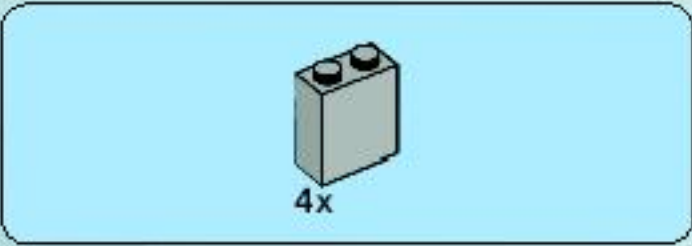

24

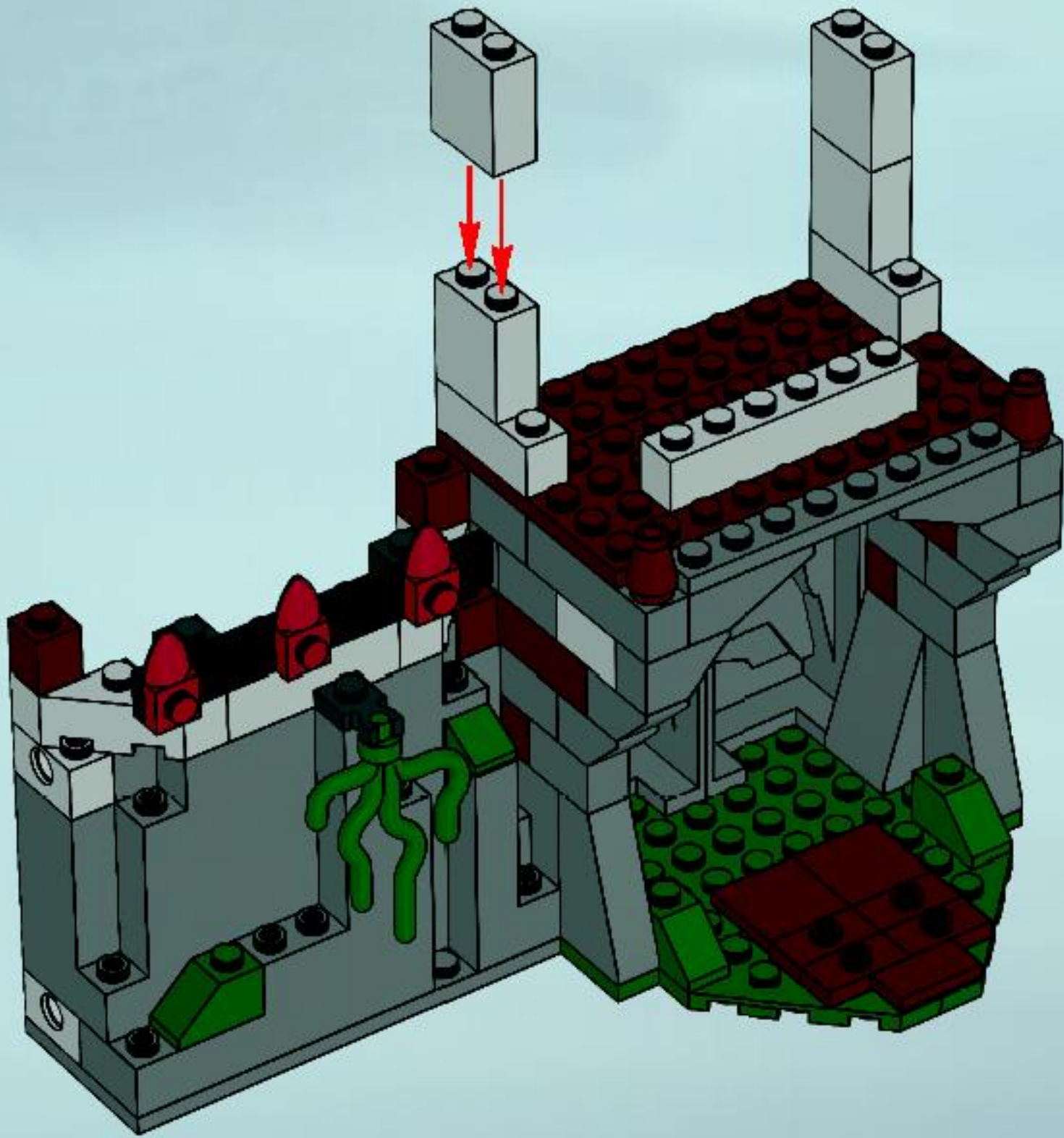



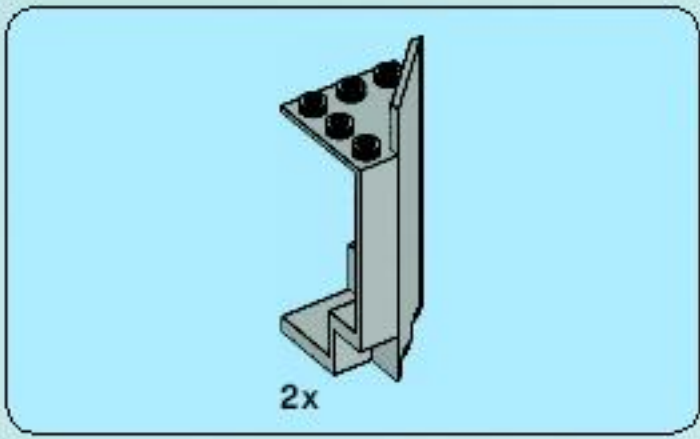

25

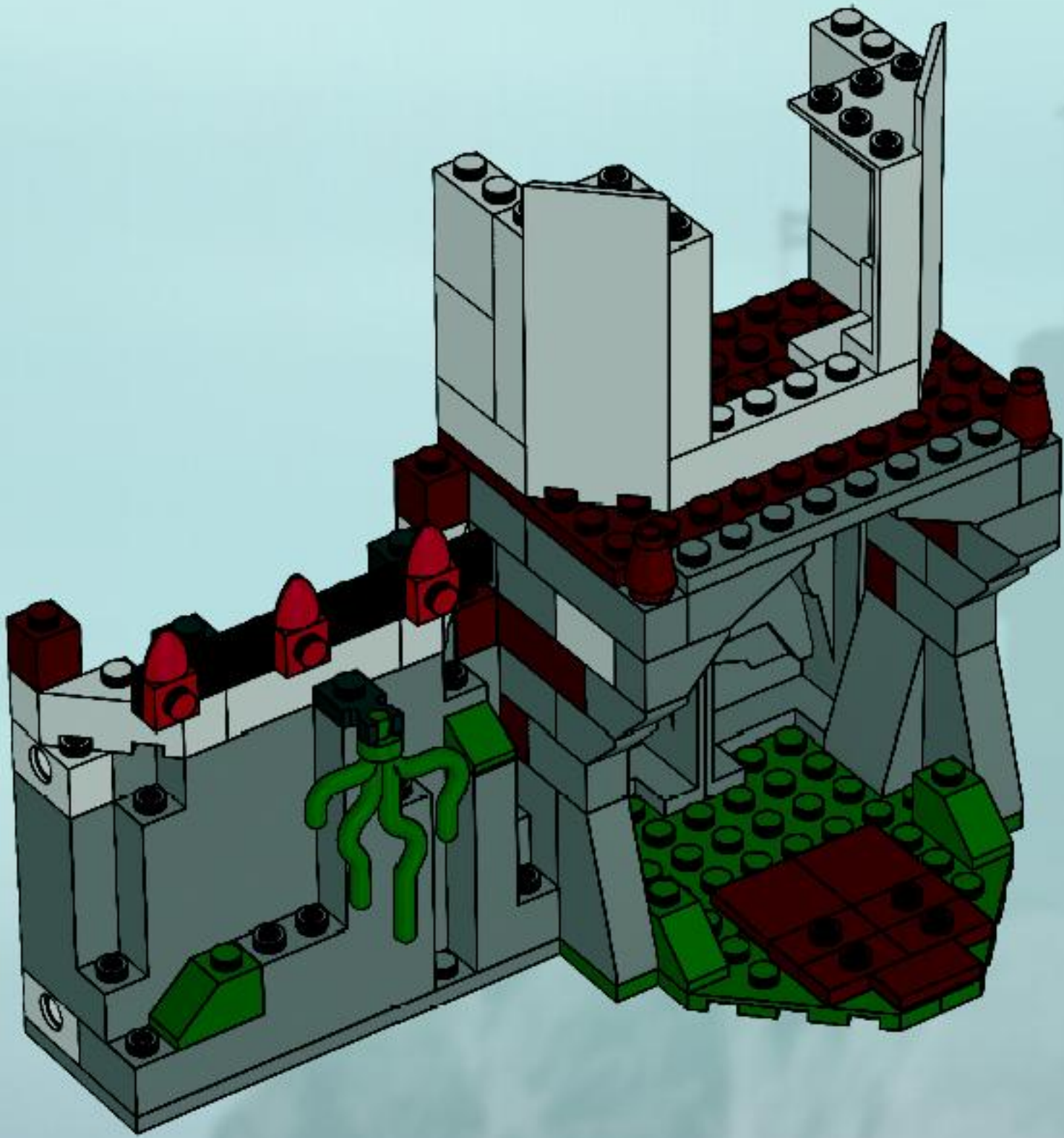



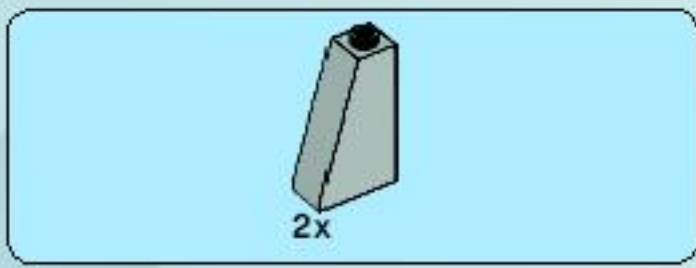

26

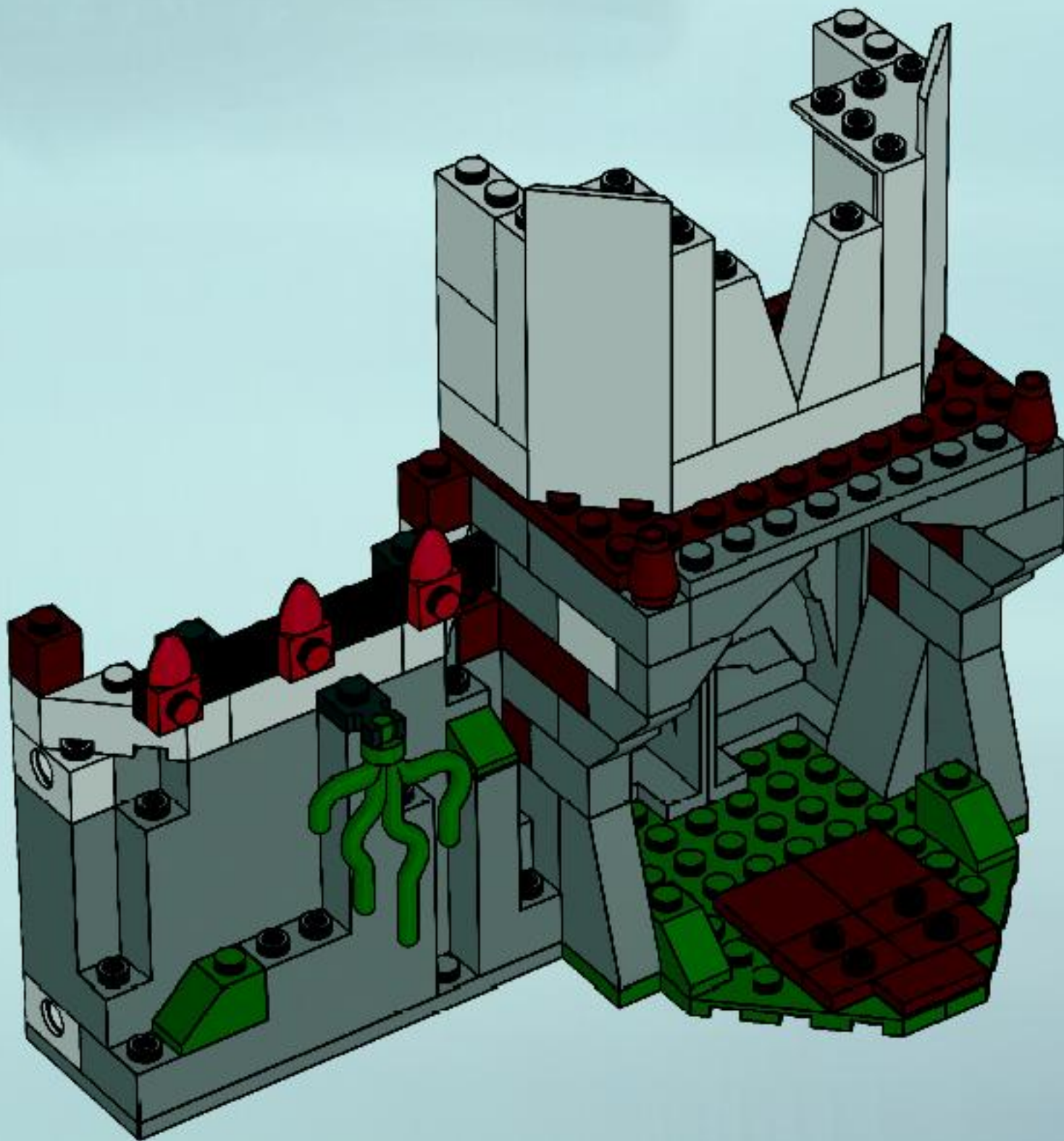



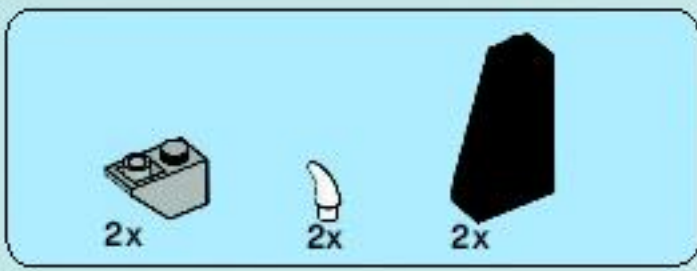

27

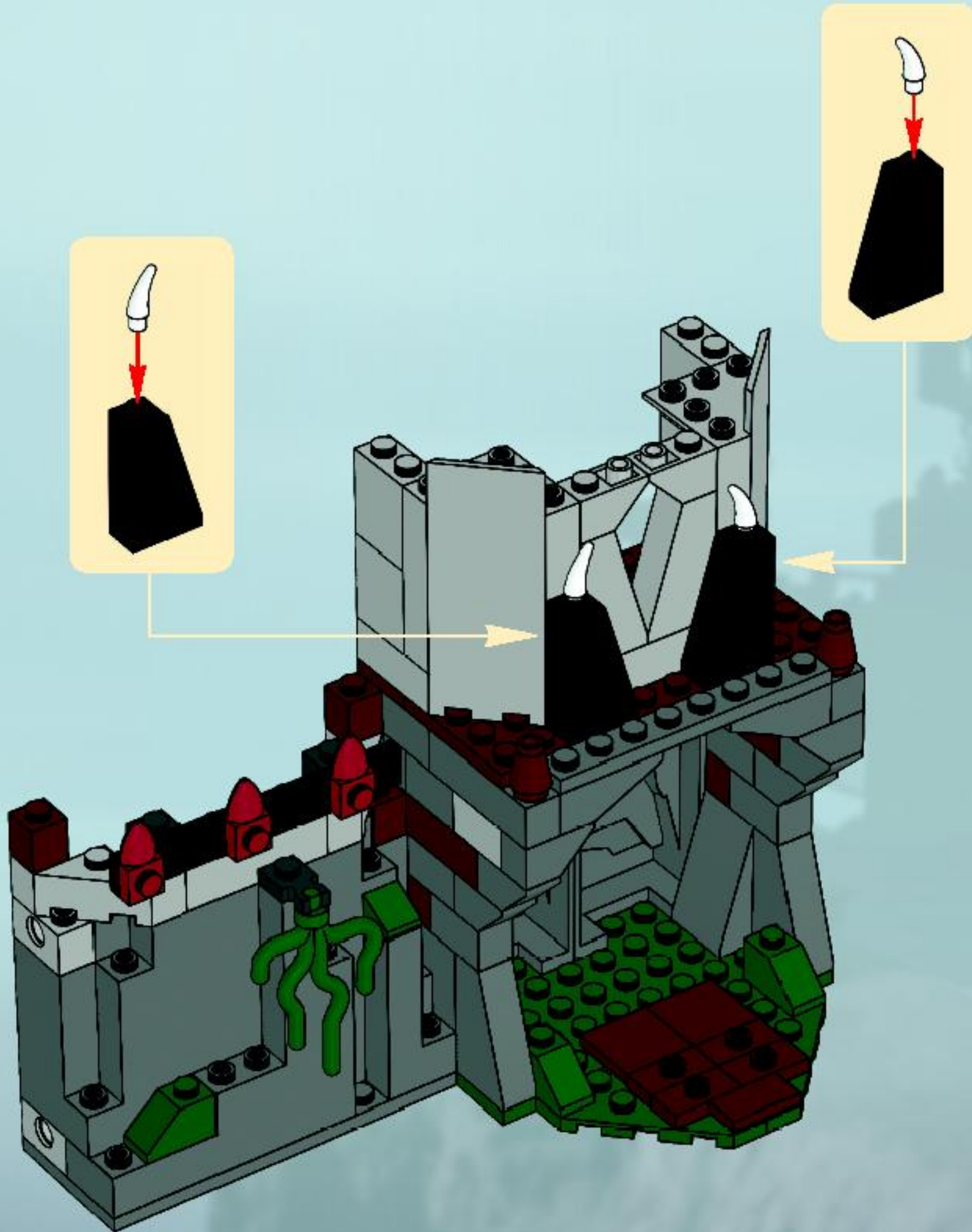





2x



2x

# 28

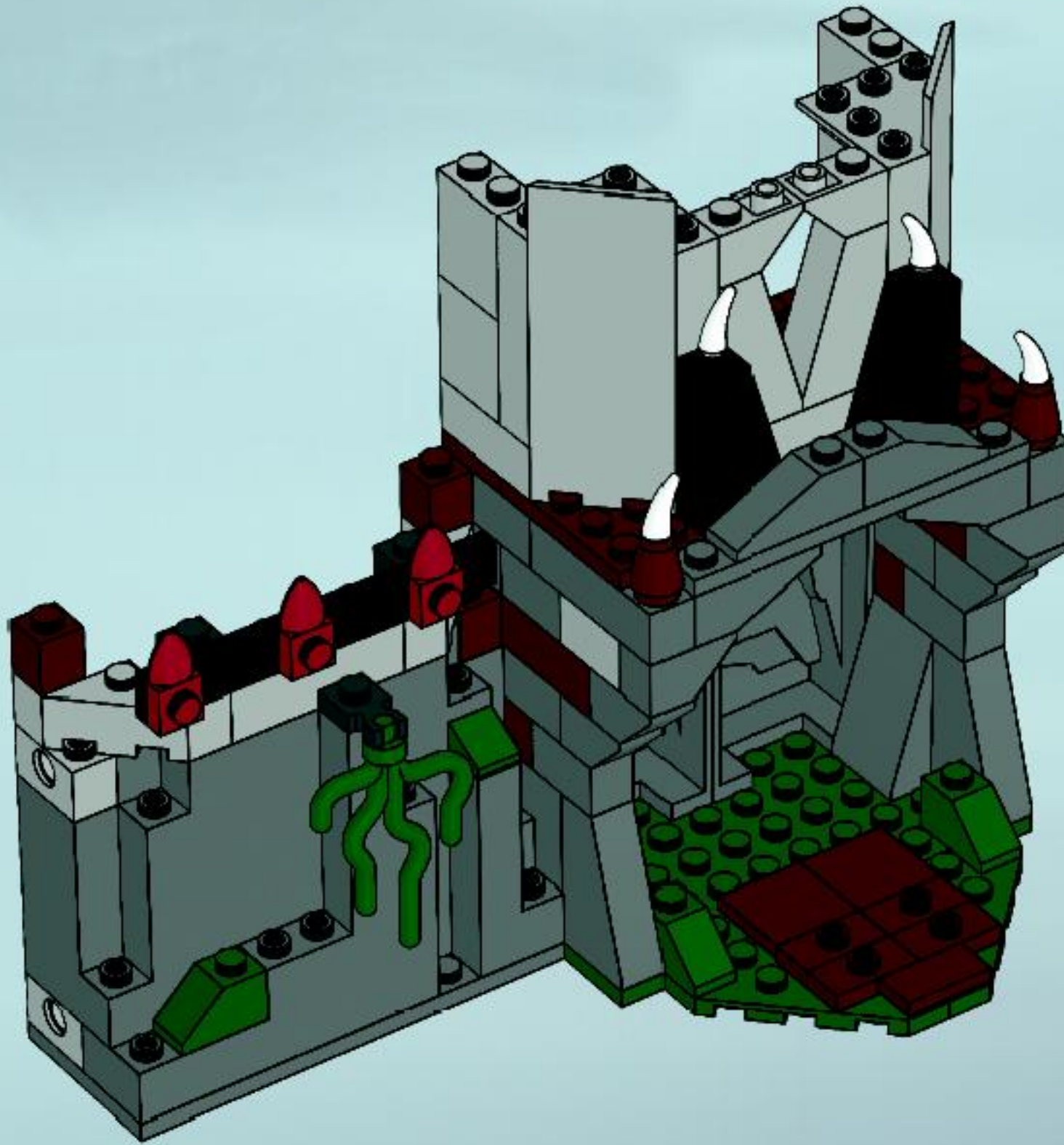





2x



4x

# 29

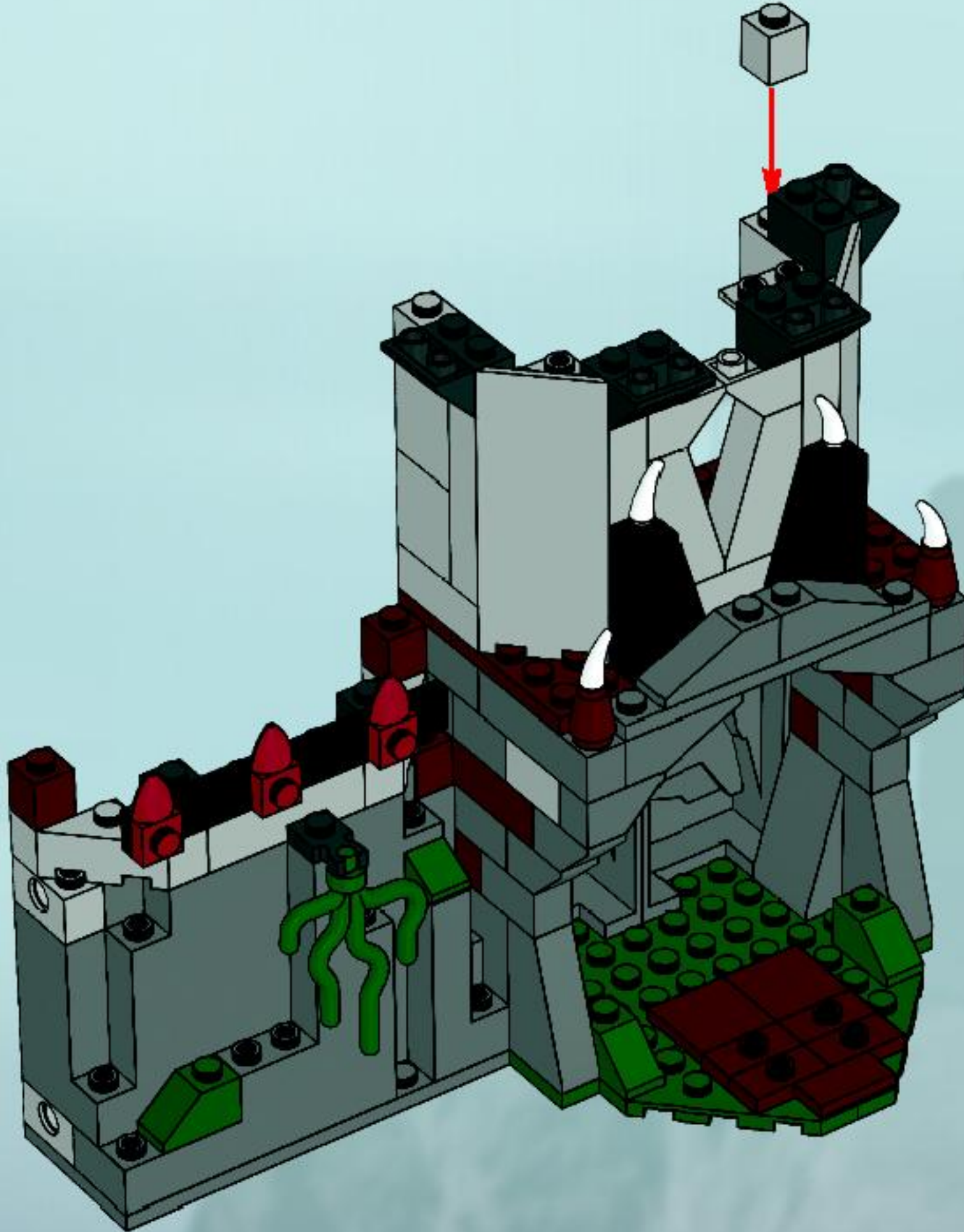



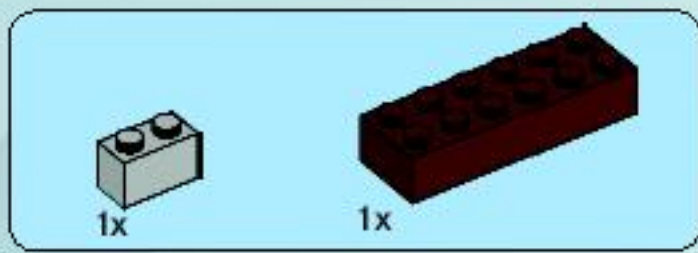

30

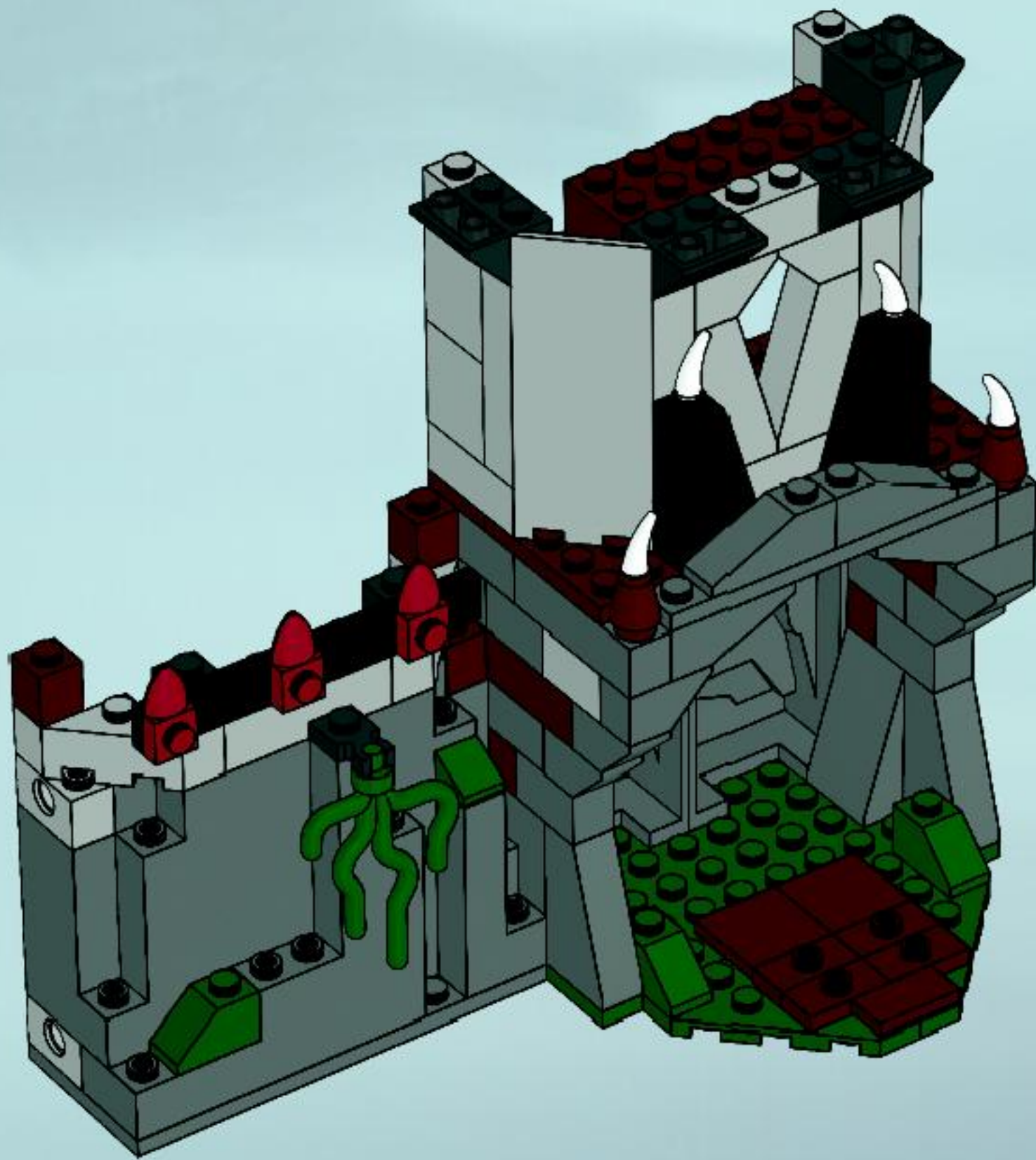



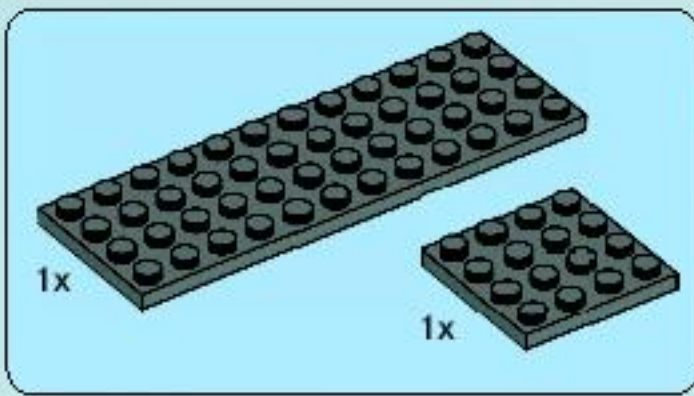

**31**

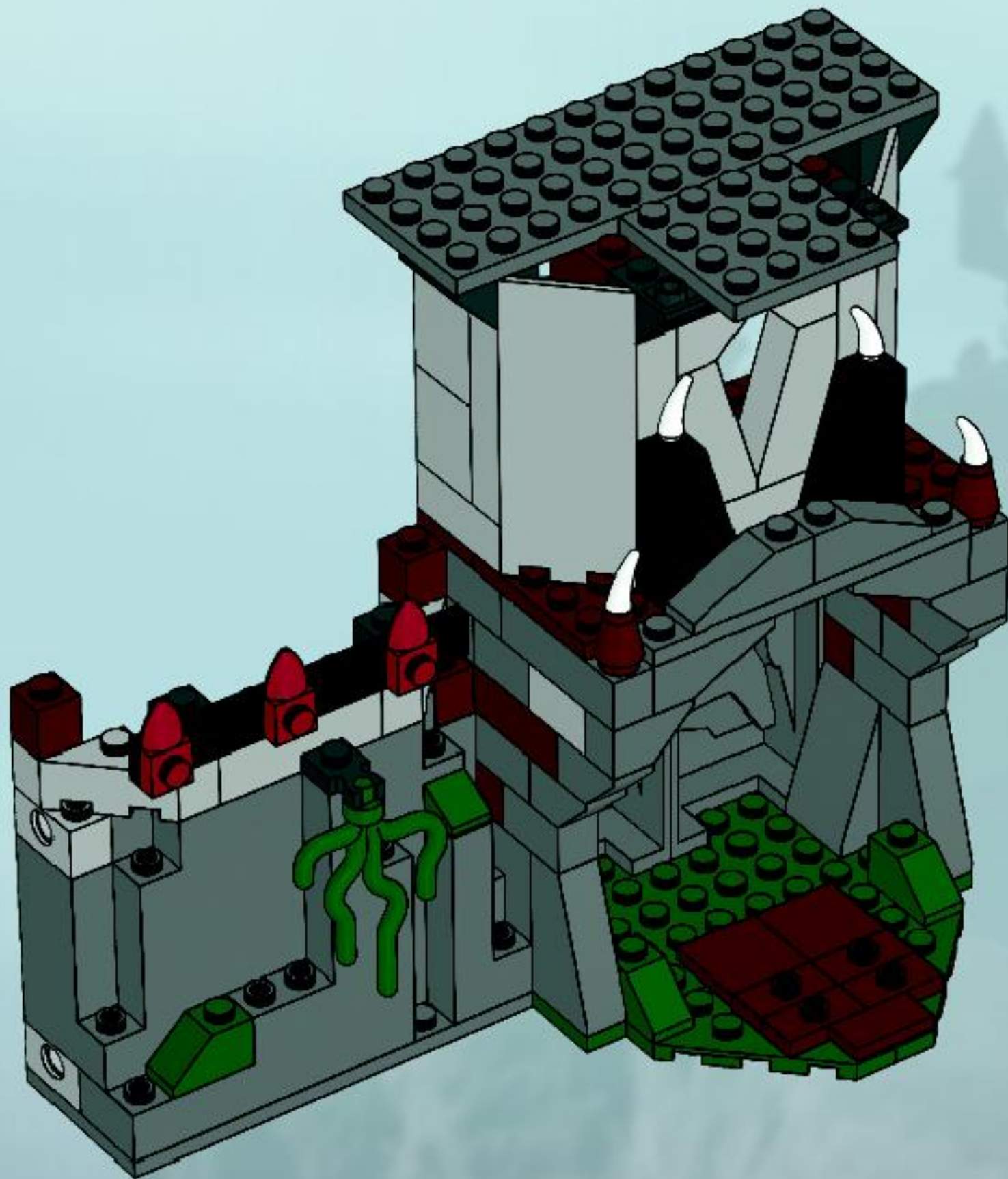





# Castle

